

Product sheet

Subminiature connector



Product	Contacts: 4, male panel mount connector, dip-solder with shielding sheet (10 mm)	Area	M9 IP67 Series 712/702
Pole	4	Article number	09 0411 35 04

Illustration



Conductor layout

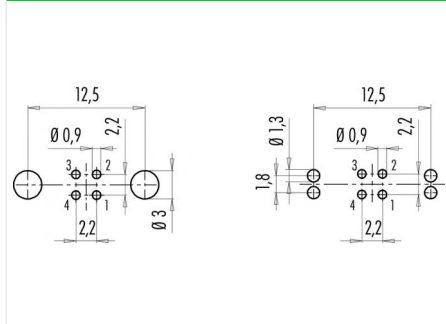

Scale drawing

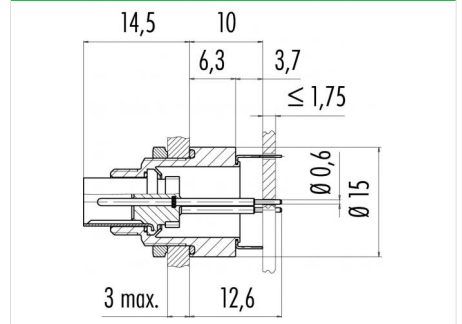

You can find the assembly instruction on the next page.

Technical data

Common values

Connector Design	Male panel mount connector
Connector locking system	screw
Termination	dip-solder
Wire gauge (mm)	-
Wire gauge (AWG)	-
Cable outlet	-
Upper temperature	85 °C
Lower temperature	-40 °C

Cable data

material housing	-
Insulation single lead	-
Single lead structure	-
Conductor resistance	-

Electrical values

Rated voltage	125 V
Rated impulse voltage	1500 V
Pollution degree	1
Overvoltage category	II
Material group	III
Rated current (40°C)	3 A
Volume resistivity	$\le 3 \text{ m}\Omega$
EMV compliance	shieldable
Degree of protection	IP67
Mechanical operation	> 500 mating cycles

Material

Material of contact	CuZn (Brass)
Contact plating	Au (Gold)
Material of contact body	PA (UL 94 V-0)
Material of housing	CuZn (Brass nickel-plated)

Contacts: 4, Male panel mount connector, dip-solder with shielding sheet (10 mm), screwed from front

Product

Contacts: 4, male panel mount connector,
dip-solder with shielding sheet (10 mm)
4

Area
Article number

M9 IP67 Series 712/702
09 0411 35 04

Pole

Installation instructions / Mounting cutout

