

Product sheet

Miniature connector



Product	Contacts: 7, Male panel mount connector, solder, with UL approval	Area	M16 IP67 Series 423/ 723/ 425
Pole	7	Article number	09 0127 09 07

Illustration

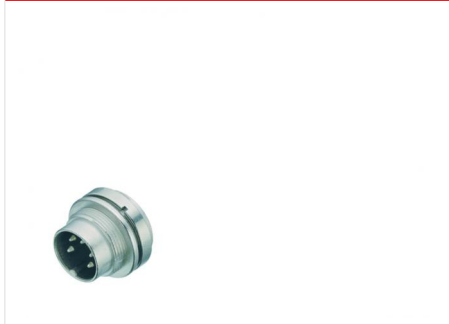

Scale drawing

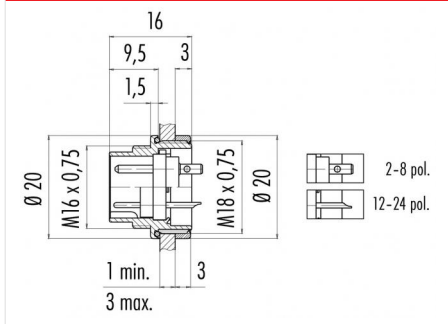

Contact Arrangement

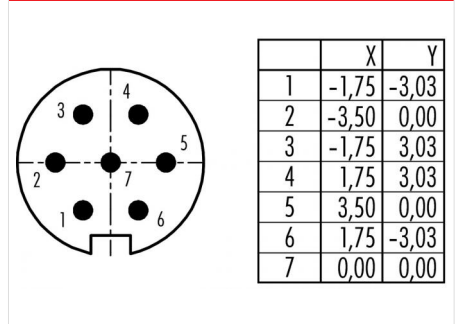

You can find the assembly instruction on the next page.

Technical data

Common values

Connector Design	Male panel mount connector
Connector locking system	screw
Termination	Solder
Wire gauge (mm)	0.75 mm ²
Wire gauge (AWG)	20
Upper temperature	95 °C
Lower temperature	-40 °C

Electrical values

Rated voltage	125 V
Rated impulse voltage	800 V
Pollution degree	1
Overvoltage category	I
Material group	III
Rated current (40°C)	5 A
Volume resistivity	≤ 3 mΩ
EMV compliance	shielded
Degree of protection	IP67
Mechanical operation	> 500 mating cycles

Material

Material of contact	CuZn (Brass)
Contact plating	Au (Gold)
Material of contact body	PBT (UL 94 V-0)
Material of housing	Nickel-plated zinc die casting

Contacts: 7, Male panel mount connector, solder, gold plated contacts, with UL approval



Product

Contacts: 7, Male panel mount connector,
solder, with UL approval
7

Area
Article number

M16 IP67 Series 423/ 723/ 425
09 0127 09 07

Pole

Installation instructions / Mounting cutout

