

# Product sheet

## Miniature connector



Product	<b>Contacts: 7 DIN, male panel mount connector</b>	Area	<b>Bayonet IP40 Series 678</b>
Pole	<b>7 DIN</b>	Article number	<b>99 0683 00 07</b>

### Illustration



### Scale drawing

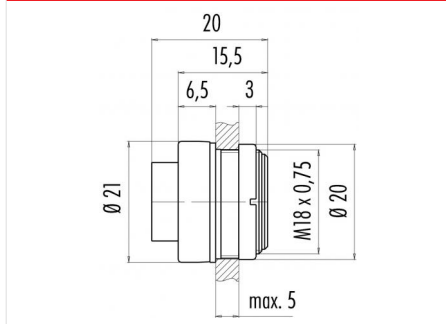

### Contact Arrangement

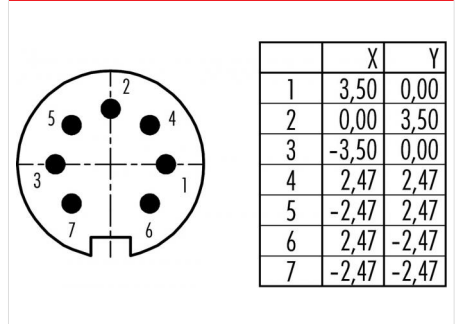

You can find the assembly instruction on the next page.

## Technical data

### Common values

Connector Design	Male panel mount connector
Connector locking system	Bayonet
Termination	Solder
Wire gauge (mm)	0.75 mm <sup>2</sup>
Wire gauge (AWG)	20
Cable outlet	-
Upper temperature	85 °C
Lower temperature	-40 °C

### Electrical values

Rated voltage	125 V
Rated impulse voltage	800 V
Pollution degree	1
Overvoltage category	I
Material group	III
Rated current (40°C)	5 A
Volume resistivity	≤ 5 mΩ
EMV compliance	not shielded
Degree of protection	IP40
Mechanical operation	> 500 mating cycles

### Material

Material of contact	CuZn (Brass)
Contact plating	Ag (Silver)
Material of contact body	PBT (UL 94 V-0)
Material of housing	PA (UL 94 V-0)

Contacts: 7 DIN, male panel mount connector

Product

Contacts: 7 DIN, male panel mount

Area

Bayonet IP40 Series 678

Pole

connector  
7 DIN

Article number

99 0683 00 07

Installation instructions / Mounting cutout

