

Product	<b>Contacts: 4, Female cable connector, PROFINET, with UL approval</b>	Area	<b>M12-D, M12-X Series 876 D-coding</b>
Pole	<b>4</b>	Article number	<b>77 4530 0000 50704 0200</b>

**Illustration**

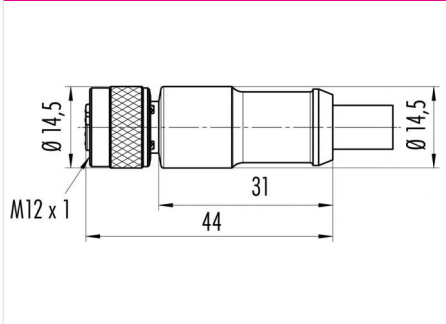

**Scale drawing**



**Technical data**

**Common values**

Connector Design	Female cable connector
Connector locking system	screw
Termination	crimp, injection-moulded cable
Wire gauge (mm)	0.25 mm <sup>2</sup>
Wire gauge (AWG)	22
Upper temperature	85 °C
Lower temperature	-25 °C

**Electrical values**

Rated voltage	250 V
Rated impulse voltage	2500 V
Pollution degree	3
Overvoltage category	II
Material group	II
Volume resistivity	≤ 3 mΩ
Degree of protection	IP67
Mechanical operation	> 500 mating cycles

**Cable data**

Approval	UL style: 20236
----------	-----------------

**Material**

Material of contact	CuSn (Bronze)
Contact plating	Au (Gold)
Material of contact body	PUR
Material of housing	PUR

Cable length: 2 m, Contacts: 4, Female cable connector, PROFINET, with UL approval