

Product sheet

Miniature connector



Product	Contacts: 12, female cable connector, cable outlet 3 - 6 mm	Area	M16 IP40 Series 680
Pole	12	Article number	09 0330 00 12

Illustration



Scale drawing

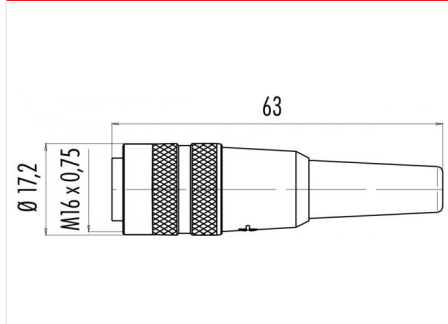

Contact Arrangement

	X	Y
A	-0,41	-3,45
B	2,29	-3,61
C	4,10	-1,21
D	3,20	1,34
E	2,71	3,59
F	0,41	3,45
G	-2,29	3,61
H	-4,10	1,21
J	-3,20	-1,34
K	-2,71	-3,59
L	-2,00	-1,51
M	-2,00	1,51

You can find the item description on the next page.

Technical data

Common values

Connector Design	Female cable connector
Connector locking system	screw
Termination	Solder
Wire gauge (mm)	0.25 mm ²
Wire gauge (AWG)	24
Cable outlet	3 - 6 mm
Upper temperature	85 °C
Lower temperature	-40 °C

Electrical values

Rated voltage	60 V
Rated impulse voltage	500 V
Pollution degree	1
Overvoltage category	I
Material group	III
Rated current (40°C)	3 A
Volume resistivity	≤ 3 mΩ
EMV compliance	not shielded
Degree of protection	IP40
Mechanical operation	> 500 mating cycles

Material

Material of contact	CuSn (Bronze)
Contact plating	Au (Gold)
Material of contact body	PBT (UL 94 V-0)
Material of housing	PA (UL 94 HB)

Contacts: 12, female cable connector, cable outlet 3 - 6 mm, gold plated contacts

Product	Contacts: 12, female cable connector, cable outlet 3 - 6 mm	Area	M16 IP40 Series 680
Pole	12	Article number	09 0330 00 12

Item description

