

Product Pole	Contacts: 5, Cable plug connector 5	Area Article number	7/8" Series 870 79 2461 20 05
--------------	---	---------------------	---

Illustration

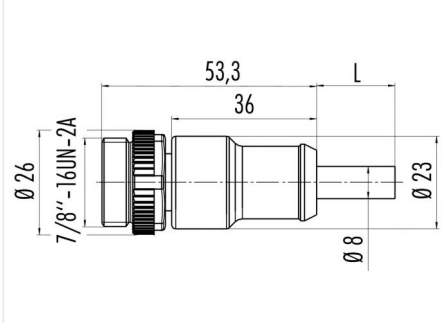

Scale drawing



Contact Arrangement

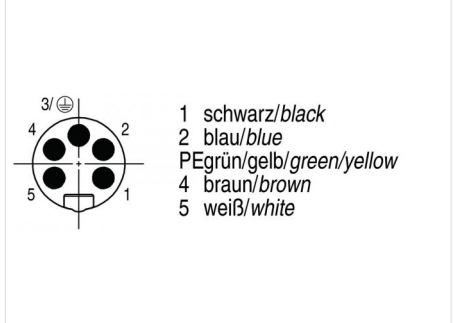

Technical data

Common values

Connector Design	Cable plug connector
Connector locking system	Screws 7/8" - 16 UN
Termination	Crimp
Wire gauge (mm)	1.50 mm ²
Wire gauge (AWG)	16
Upper temperature	85 °C
Lower temperature	-25 °C

Cable data

material housing	PUR
Insulation single lead	TPM
Single lead structure	82 x 0.15 mm
Cable sheath Ø	8.7
Conductor resistance	-
Temperature range cable movable c from	-20
Temperature range cable movable c to	80
Temperature range cable fixed c from	-50
Temperature range cable fixed c to	80
Bending radius cable fixed	-
Bending radius cable movable	7.5 x d

Electrical values

Rated voltage	300 V
Rated impulse voltage	4000 V
Pollution degree	3
Overvoltage category	II
Material group	II
Rated current (40°C)	9 A
Volume resistivity	≤ 3 mΩ
EMV compliance	-
Degree of protection	IP68
Mechanical operation	> 100 mating cycles

Material

Material of contact	CuZn (Brass)
Contact plating	Au (Gold)
Material of contact body	PUR
Material of housing	PUR

Contacts: 5, Cable: 5 x 1.5 PUR, cable plug connector, cable length: 2 m