

# Product sheet

## Miniature connector



Product	<b>Contacts: 4, Female panel mount connector, solder, 2 - 8 contacts</b>	Area	<b>M16 IP40 Series 581/ 680/ 682</b>
Pole	<b>4</b>	Article number	<b>09 0312 00 04</b>

### Illustration



### Scale drawing

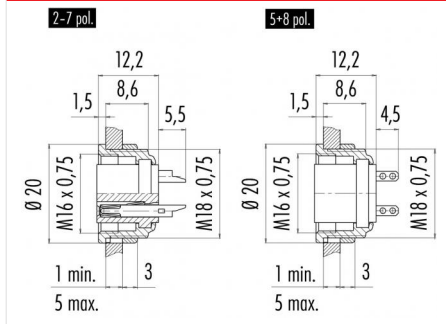

### Contact Arrangement

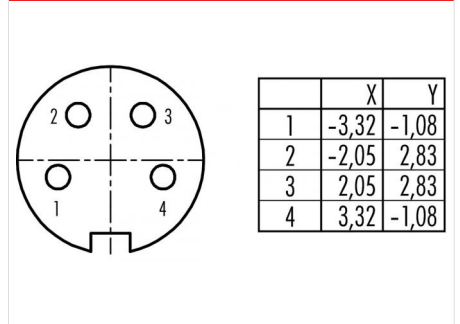

You can find the assembly instruction on the next page.

## Technical data

### Common values

Connector Design	Female panel mount connector
Connector locking system	screw
Termination	Solder
Wire gauge (mm)	0.75 mm <sup>2</sup>
Wire gauge (AWG)	20
Upper temperature	85 °C
Lower temperature	-40 °C

### Electrical values

Rated voltage	250 V
Rated impulse voltage	1500 V
Pollution degree	1
Overvoltage category	I
Material group	III
Rated current (40°C)	6 A
Volume resistivity	≤ 5 mΩ
EMV compliance	shielded
Degree of protection	IP40
Mechanical operation	> 500 mating cycles

### Material

Material of contact	CuSn (Bronze)
Contact plating	Ag (Silver)
Material of contact body	PBT (UL 94 V-0)
Material of housing	Nickel-plated zinc die casting

Contacts: 4, Female panel mount connector, solder, 2 - 8 contacts, silver plated contacts

Product

Contacts: 4, Female panel mount connector, solder, 2 - 8 contacts  
4

Area  
Article number

M16 IP40 Series 581/ 680/ 682  
09 0312 00 04

Pole

Installation instructions / Mounting cutout

