

Product **Contacts: 12, Female panel mount connector, lightgrey, dip-solder termination**
 Area **Snap-in IP67, miniature Series**
 Article number **99 9136 490 12**

Scale drawing

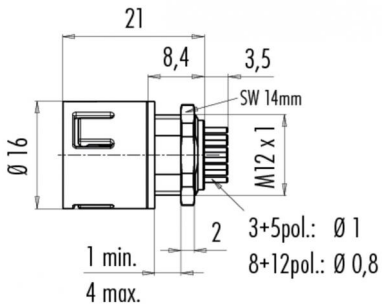

Contact Arrangement

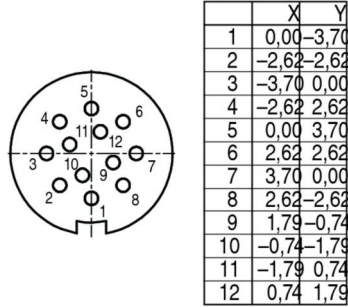

You can find the item description and assembly instruction on the next page.

Technical data

General features

Connector Design female panel mount connector
 Connector locking system snap
 Termination dip-solder
 Wire gauge (mm) 0,25 mm²
 Wire gauge (AWG) 24
 Upper temperature 85 °C
 Lower temperature -25 °C

Electrical parameters

Rated voltage 60 V
 Rated impulse voltage 800 V
 Pollution degree 2
 Overvoltage category II
 Material group II
 Rated current (40°C) 2 A
 Volume resistivity ≤ 3 mΩ
 EMV compliance not shielded
 Degree of protection IP67

Material

Material of contact CuZn (Messing)
 Contact plating Au (gold)
 Material of contact body PA (UL 94 V-0)

Product **Contacts: 12, Female panel mount connector, lightgrey, dip-solder termination**
Area **Snap-in IP67, miniature Series**
Article number **99 9136 490 12**

Item description

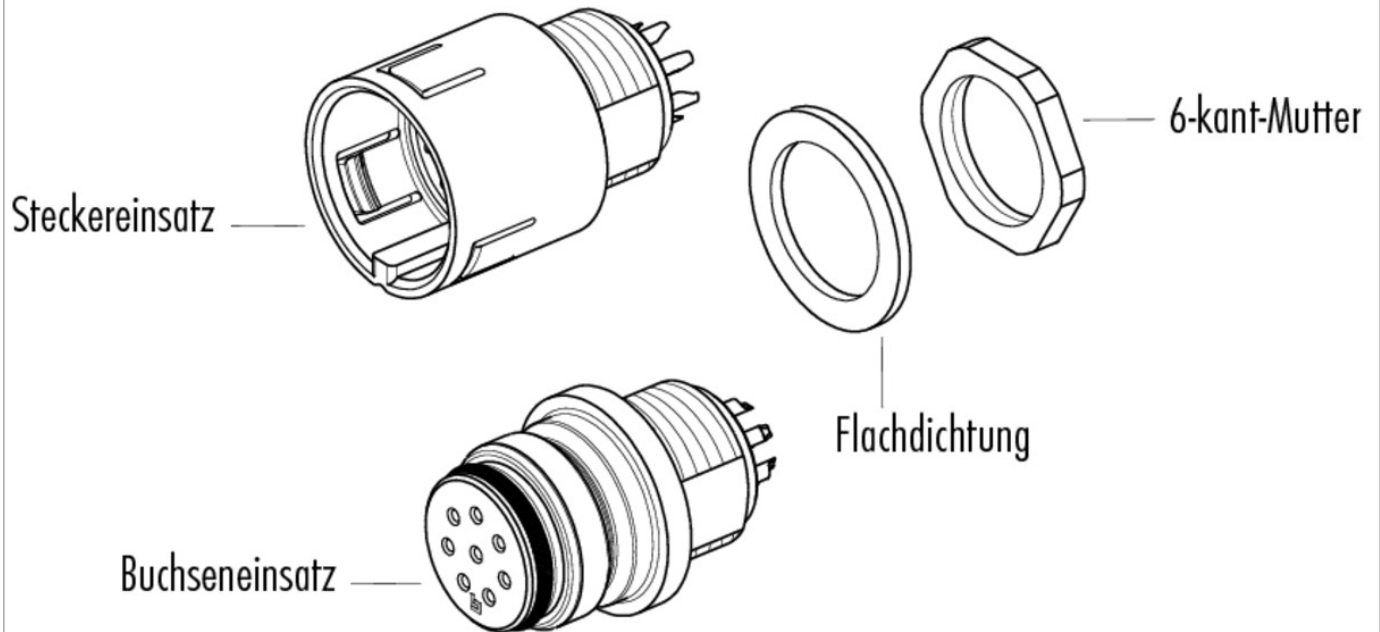

Installation instructions / Mounting cutout

