

Product sheet
Miniature connector



Product	Contacts: 8 DIN, Female angled connector, cable outlet 4 – 6 mm, metal model, shieldable	Area	M16 IP40 Series 682
Pole	8 DIN	Article number	99 0154 10 08

Illustration



Scale drawing

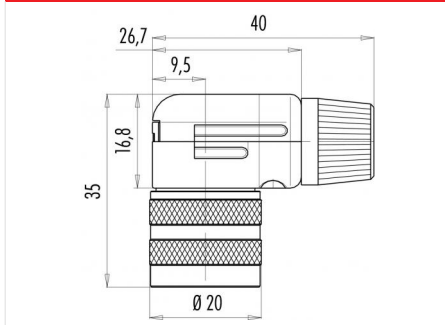

Contact Arrangement

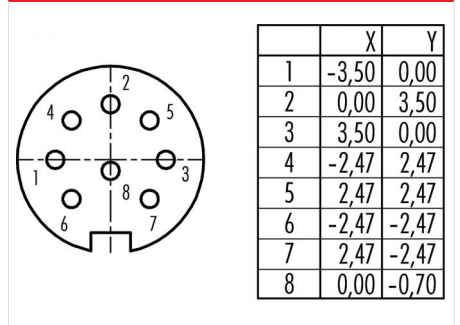

You can find the item description on the next page.

Technical data

Common values

Connector Design	Female angled connector
Connector locking system	screw
Termination	Solder
Wire gauge (mm)	0.75 mm ²
Wire gauge (AWG)	20
Cable outlet	4 - 6 mm
Upper temperature	85 °C
Lower temperature	-40 °C

Electrical values

Rated voltage	60 V
Rated impulse voltage	500 V
Pollution degree	1
Overvoltage category	I
Material group	III
Rated current (40°C)	5 A
Volume resistivity	≤ 5 mΩ
EMV compliance	shielded
Degree of protection	IP40
Mechanical operation	> 500 mating cycles

Material

Material of contact	CuSn (Bronze)
Contact plating	Ag (Silver)
Material of contact body	PBT (UL 94 V-0)
Material of housing	PA (UL 94 HB)

Contacts: 8 DIN, Female angled connector, cable outlet 4 – 6 mm, metal model, shieldable, silver plated contacts

Product sheet
Miniature connector



Product	Contacts: 8 DIN, Female angled connector, cable outlet 4 – 6 mm, metal model, shieldable	Area	M16 IP40 Series 682
Pole	8 DIN	Article number	99 0154 10 08

Item description

