

Product sheet

Miniature connector

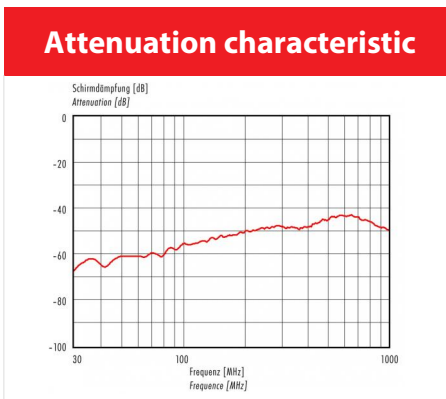

Product	Contacts: 4, cable plug connector with cable clamp, shieldable, cable outlet 4 – 6 mm	Area	M16 IP40 Series 581
Pole	4	Article number	99 2009 10 04

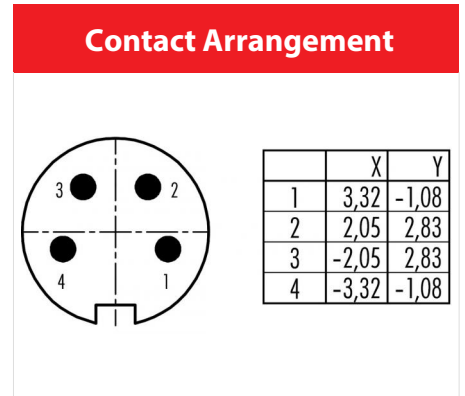
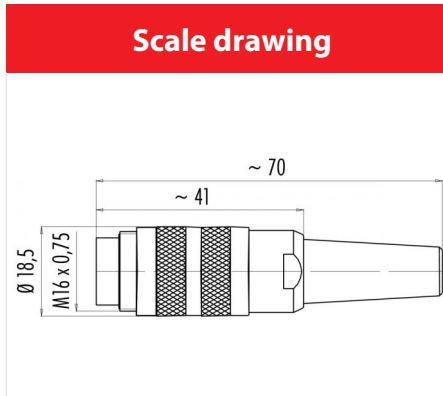

You can find the item description on the next page.

Technical data

Common values

Connector Design	Cable plug connector
Connector locking system	screw
Termination	Solder
Wire gauge (mm)	0.75 mm ²
Wire gauge (AWG)	20
Cable outlet	4 - 6 mm
Upper temperature	85 °C
Lower temperature	-40 °C

Electrical values

Rated voltage	250 V
Rated impulse voltage	1500 V
Pollution degree	1
Overvoltage category	I
Material group	III
Rated current (40°C)	6 A
Volume resistivity	≤ 5 mΩ
EMV compliance	shielded
Degree of protection	IP40
Mechanical operation	> 500 mating cycles

Material

Material of contact	CuZn (Brass)
Contact plating	Ag (Silver)
Material of contact body	PBT (UL 94 V-0)
Material of housing	CuZn (Brass nickel-plated)

Contacts: 4, Cable plug connector with cable clamp, shieldable, cable outlet 4 - 6 mm, silver plated contacts

Product	Contacts: 4, cable plug connector with cable clamp, shieldable, cable outlet 4 – 6 mm	Area	M16 IP40 Series 581
Pole	4	Article number	99 2009 10 04

Item description

