

Product sheet

Subminiature connector



Product	Contacts: 8, Female panel mount connector, dip-solder	Area	M9 IP40 Series 711
Pole	8	Article number	09 0482 22 08

Illustration



Scale drawing

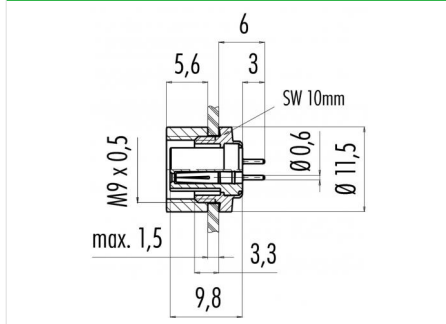

Contact Arrangement

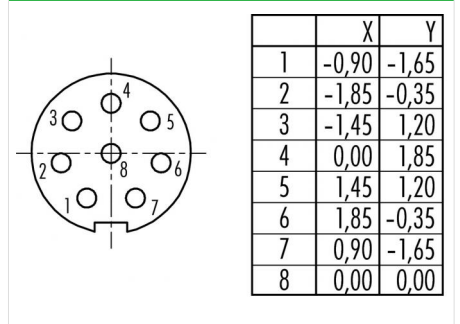

You can find the assembly instruction on the next page.

Technical data

Common values

Connector Design	Female panel mount connector
Connector locking system	screw
Termination	dip-solder
Wire gauge (mm)	-
Wire gauge (AWG)	-
Cable outlet	-
Upper temperature	85 °C
Lower temperature	-40 °C

Electrical values

Rated voltage	125 V
Rated impulse voltage	1500 V
Pollution degree	1
Overvoltage category	II
Material group	III
Rated current (40°C)	1 A
Volume resistivity	≤ 3 mΩ
EMV compliance	not shieldable
Degree of protection	IP40
Mechanical operation	> 500 mating cycles

Cable data

material housing	-
Insulation single lead	-
Single lead structure	-
Conductor resistance	-

Material

Material of contact	CuSn (Bronze)
Contact plating	Au (Gold)
Material of contact body	PA (UL 94 V-0)
Material of housing	CuZn (Brass nickel-plated)

Contacts: 8, Female panel mount connector, dip-solder

Product

**Contacts: 8, Female panel mount
connector, dip-solder**
8

Area
Article number

M9 IP40 Series 711
09 0482 22 08

Pole

Installation instructions / Mounting cutout

