

Product	<b>Contacts: 5, female panel mount connector</b>
Area	<b>Snap-in IP67, subminiature Series</b>
Article number	<b>99 9216 490 05</b>

**Illustration**

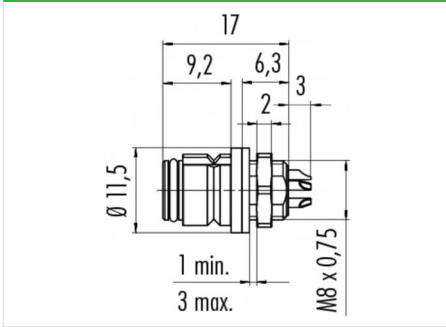

**Scale drawing**



**Contact Arrangement**

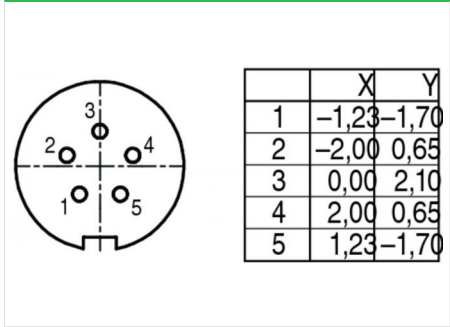

You can find the item description and assembly instruction on the next page.

**Technical data**

**General features**

Connector Design	female panel mount connector
Connector locking system	snap
Termination	dip-solder
Wire gauge (mm)	0,25 mm <sup>2</sup>
Wire gauge (AWG)	24
Cable outlet	3 - 5 mm
Upper temperature	85 °C
Lower temperature	-25 °C

**Electrical parameters**

Rated voltage	63 V
Rated impulse voltage	800 V
Pollution degree	2
Overvoltage category	II
Material group	II
Rated current (40°C)	2 A
Volume resistivity	≤ 3 mΩ
EMV compliance	Shielding is not possible
Degree of protection	IP67

**Material**

Material of contact	CuSn (Bronze)
Contact plating	Au (gold)
Material of contact body	PA (UL 94 V-0)

Product **Contacts: 5, female panel mount connector**

Area **Snap-in IP67, subminiature Series**  
Article number **99 9216 490 05**

Item description

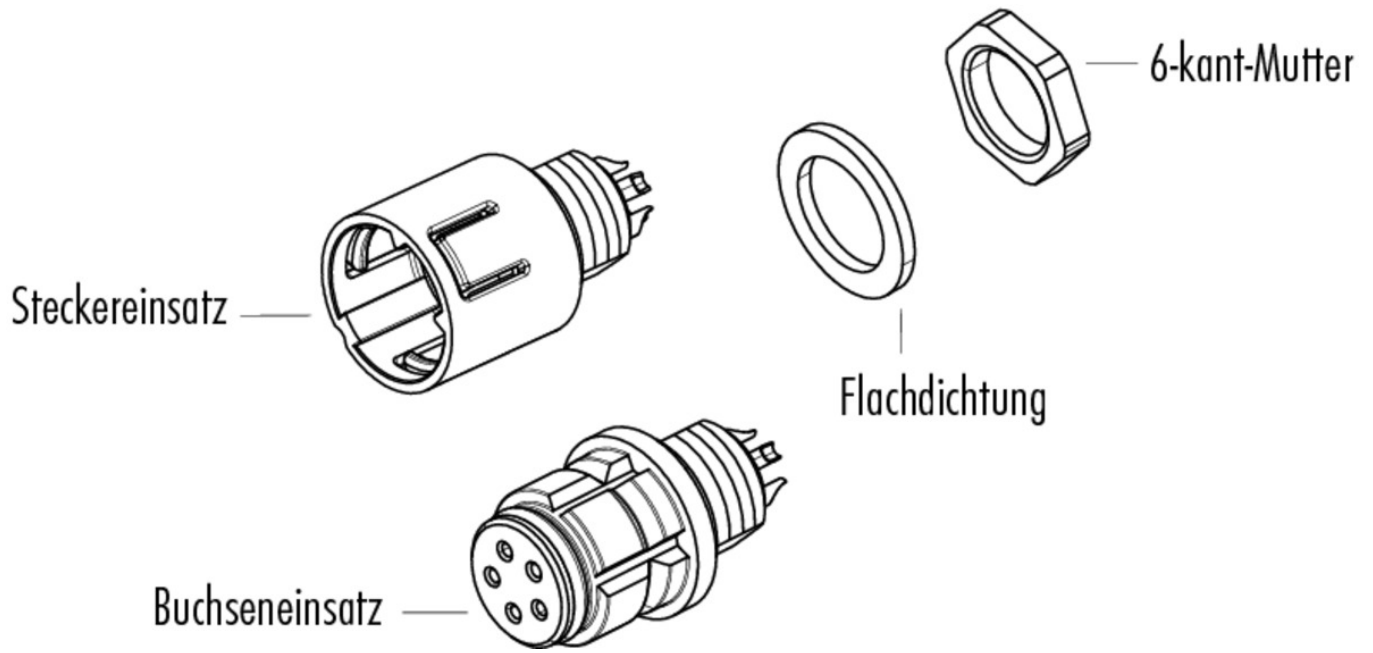

Installation instructions / Mounting cutout

