

Product sheet

Subminiature connector



Product	Contacts: 2, Male panel mount connector, solder	Area	M9 IP67 Series 712/702
Pole	2	Article number	09 0403 00 02

Illustration



Scale drawing

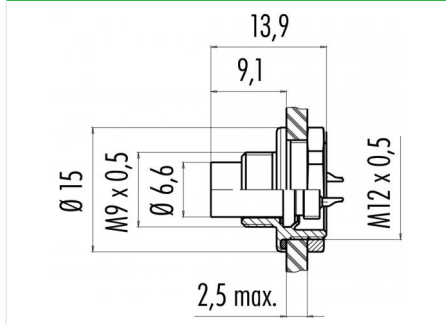

Contact Arrangement

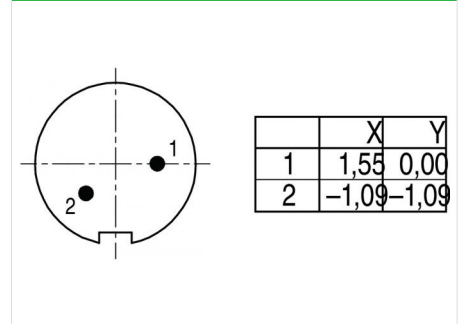

You can find the assembly instruction on the next page.

Technical data

Common values

Connector Design	Male panel mount connector
Connector locking system	screw
Termination	Solder
Wire gauge (mm)	0.25 mm ²
Wire gauge (AWG)	24
Cable outlet	-
Upper temperature	85 °C
Lower temperature	-40 °C

Cable data

material housing	-
Insulation single lead	-
Single lead structure	-
Conductor resistance	-

Electrical values

Rated voltage	125 V
Rated impulse voltage	1500 V
Pollution degree	1
Overvoltage category	II
Material group	III
Rated current (40°C)	4 A
Volume resistivity	≤ 3 mΩ
EMV compliance	shieldable
Degree of protection	IP67
Mechanical operation	> 500 mating cycles

Material

Material of contact	CuZn (Brass)
Contact plating	Au (Gold)
Material of contact body	PA (UL 94 V-0)
Material of housing	CuZn (Brass nickel-plated)

Contacts: 2, Male panel mount connector, solder

Product

Contacts: 2, Male panel mount connector,
solder
2

Area
Article number

M9 IP67 Series 712/702
09 0403 00 02

Pole

Installation instructions / Mounting cutout

