

Product sheet

Miniature connector



Product	Contacts: 7, Male panel mount connector, solder, screwed from front	Area	M16 IP40 Series 581/ 680/ 682
Pole	7	Article number	09 0327 80 07

Illustration



Scale drawing

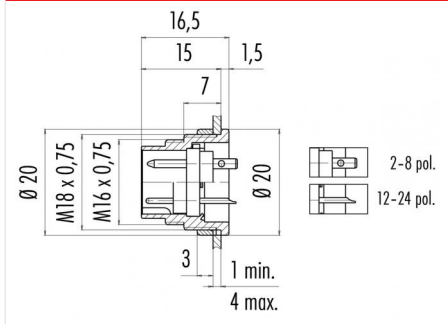

Contact Arrangement

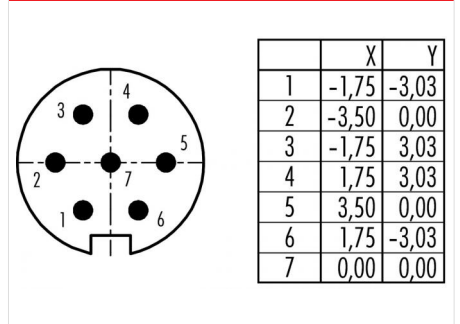

You can find the assembly instruction on the next page.

Technical data

Common values

Connector Design	Male panel mount connector
Connector locking system	screw
Termination	Solder
Wire gauge (mm)	0.75 mm ²
Wire gauge (AWG)	20
Upper temperature	85 °C
Lower temperature	-40 °C

Electrical values

Rated voltage	125 V
Rated impulse voltage	800 V
Pollution degree	1
Overvoltage category	I
Material group	III
Rated current (40°C)	5 A
Volume resistivity	≤ 5 mΩ
EMV compliance	shielded
Degree of protection	IP40
Mechanical operation	> 500 mating cycles

Material

Material of contact	CuZn (Brass)
Contact plating	Ag (Silver)
Material of contact body	PBT (UL 94 V-0)
Material of housing	Nickel-plated zinc die casting

Contacts: 7, Male panel mount connector, solder, screwed from front, silver plated contacts

Product

Contacts: 7, Male panel mount connector,
solder, screwed from front
7

Area
Article number

M16 IP40 Series 581/ 680/ 682
09 0327 80 07

Pole

Installation instructions / Mounting cutout

