

Product sheet

Miniature connector



Product	Contacts: 14, cable plug connector, cable outlet 3 - 6 mm	Area	M16 IP40 Series 680
Pole	14	Article number	09 0341 00 14

Illustration



Scale drawing

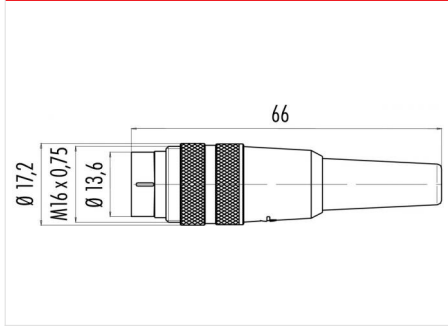

Contact Arrangement

	X	Y
A	-2,50	-4,00
C	-4,25	0,00
E	-2,30	4,00
G	2,30	4,00
J	4,25	0,00
L	2,50	-4,00
M	-0,95	-2,40
N	-2,40	-0,95
O	-2,40	0,95
P	-0,95	2,40
R	0,95	2,40
S	2,40	0,95
T	2,40	-0,95
U	0,95	-2,40

You can find the item description on the next page.

Technical data

Common values

Connector Design	Cable plug connector
Connector locking system	screw
Termination	Solder
Wire gauge (mm)	0.25 mm ²
Wire gauge (AWG)	24
Cable outlet	3 - 6 mm
Upper temperature	85 °C
Lower temperature	-40 °C

Electrical values

Rated voltage	60 V
Rated impulse voltage	500 V
Pollution degree	1
Overvoltage category	I
Material group	III
Rated current (40°C)	3 A
Volume resistivity	≤ 3 mΩ
EMV compliance	not shielded
Degree of protection	IP40
Mechanical operation	> 500 mating cycles

Material

Material of contact	CuZn (Brass)
Contact plating	Au (Gold)
Material of contact body	PBT (UL 94 V-0)
Material of housing	PA (UL 94 HB)

Contacts: 14, cable plug connector, cable outlet 3 - 6 mm, gold plated contacts

Product sheet
Miniature connector

Product	Contacts: 14, cable plug connector, cable outlet 3 - 6 mm	Area	M16 IP40 Series 680
Pole	14	Article number	09 0341 00 14

Item description

