



inserts:		page:
CD	25 poles + ⊕	56
CDD	38 poles + ⊕	68
CSAH	16 poles + ⊕	88
CDA	16 poles + ⊕	100
CDC	16 poles + ⊕	101

bulkhead mounting housings with single lever



NEW

surface mounting housings with single lever

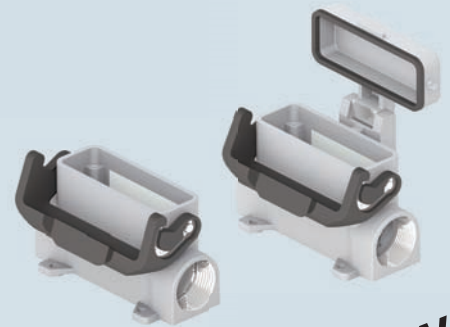

NEW

description	part No.	part No.	entry Pg	part No.	entry M
with single lever	CZI 25 L				
with single lever and cover	CZI 25 LS				
with single lever, high construction		CZAP 25 L	16		
with single lever, high construction		CZAP 25 L2	16 x 2		
with single lever, high construction		CZAP 25 L21	21	MZAP 25 L25	25
with single lever, high construction		CZAP 25 L221	21 x 2	MZAP 25 L225	25 x 2
with single lever and cover, high construction		CZAP 25LS	16		
with single lever and cover, high construction		CZAP 25LS2	16 x 2		
with single lever and cover, high construction		CZAP 25LS21	21	MZAP 25LS25	25
with single lever and cover, high construction		CZAP 25LS221	21 x 2	MZAP 25LS225	25 x 2

panel cut-out for bulkhead mounting housings in mm

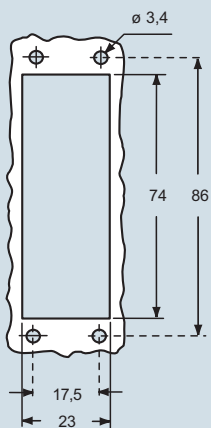

dimensions in mm

CZI L

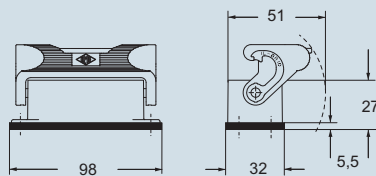

CZI LS

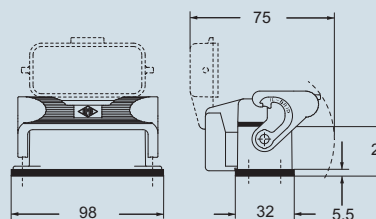

dimensions in mm

CZAP L and MZAP L

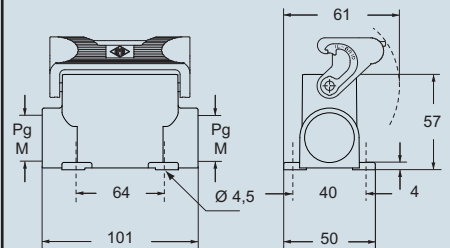

CZAP LS and MZAP LS

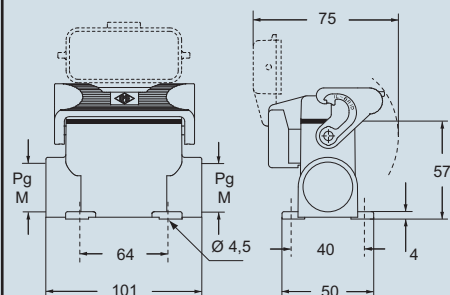

N.B.:
The enclosures ensure IP66 protection (or IP65 for hinged cover versions) rating when mated and locked with the closing levers.

CALUS Type 4/4X/12



dimensions shown are not binding and may be changed without notice

IL-BRID - size 66.16



inserts:		page:
CD	25 poles + ⊕	56
CDD	38 poles + ⊕	68
CSAH	16 poles + ⊕	88
CDA	16 poles + ⊕	100
CDC	16 poles + ⊕	101

refer to catalogue page CN.16

insert centre distance:
66 x 16 mm

bulkhead mounting housings
with 1 lever



IL-BRID
lever

NEW

description	part No.
with single lever and cover	CZI 25 LSP

panel cut-out for bulkhead mounting housings in mm

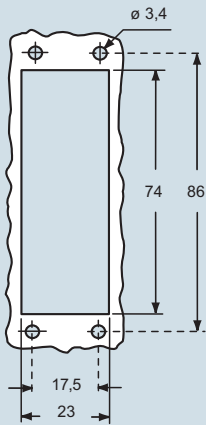

dimensions in mm

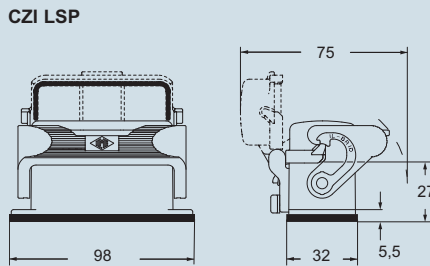

N.B.:
The enclosures ensure IP66 protection rating when mated and locked with the closing levers.



dimensions shown are not binding
and may be changed without notice



inserts:		page:
CD	25 poles + ⊕	56
CDD	38 poles + ⊕	68
CSAH	16 poles + ⊕	88
CDA	16 poles + ⊕	100
CDC	16 poles + ⊕	101

hoods with 2 pegs



hoods with 2 pegs, double top entry



description	part No.		entry		part No.		entry	
			Pg	M			Pg	M
with pegs, side entry	CZO 25 L	16	MZO 25 L20	20				
with pegs, side entry			MZO 25 L25	25				
with pegs, side entry, high construction	CZAO 25 L16	16	MZAO 25 L20	20				
with pegs, side entry, high construction	CZAO 25 L21	21	MZAO 25 L25	25				
with pegs, top entry	CZV 25 L	16	MZV 25 L20 **	20				
with pegs, top entry, high construction	CZAV 25 L16	16	MZAV 25 L20	20				
with pegs, top entry, high construction	CZAV 25 L21	21	MZAV 25 L25	25				
with pegs, side entry, high construction, without adaptor *	CZFO 25 L16	16	MZFO 25 L20	20				
with pegs, side entry, high construction, without adaptor *	CZFO 25 L21	21	MZFO 25 L25	25				
with pegs, top entry, high construction, without adaptor *	CZFV 25 L16	16	MZFV 25 L20	20				
with pegs, top entry, high construction, without adaptor *	CZFV 25 L21	21	MZFV 25 L25	25				
with pegs for 1 lever					CZAV 25 L216	16 x 2	MZAV 25 L220	20 x 2
with pegs for 1 lever, without adaptor *					CZFV 25 L216	16 x 2	MZFV 25 L220	20 x 2

* enclosure without adaptor, threaded on the body, to be used only with a complete cable gland.

** can only be used with a complete cable gland (to be purchased separately)

dimensions in mm

CZO L and MZO L

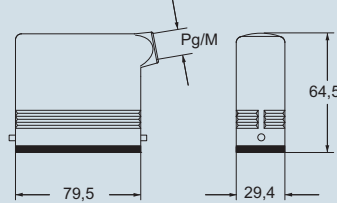

CZAO L - MZAO L and CZAV L - MZAV L

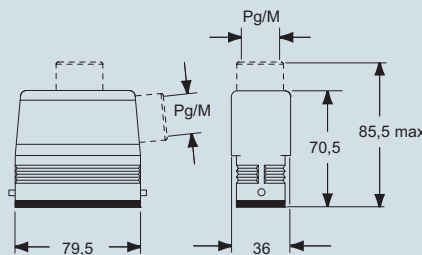

CZV L and MZV L

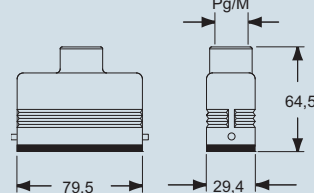

CZFO L - MZFO L and CZFV L - MZFV L

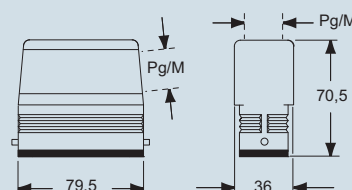

dimensions in mm

CZAV/CZVF L2 and (MZAV)/MZFV L2

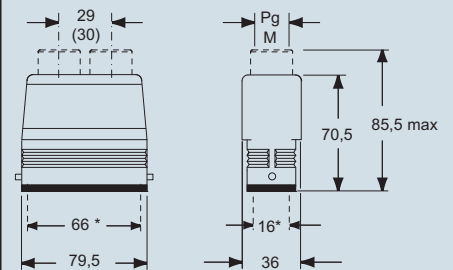

CALUS Type 4/4X/12



dimensions shown are not binding and may be changed without notice

IL-BRID - size 66.16



inserts:		page:
CD	25 poles + ⊕	56
CDD	38 poles + ⊕	68
CSAH	16 poles + ⊕	88
CDA	16 poles + ⊕	100
CDC	16 poles + ⊕	101

Cover versions L and LG cannot be used together with coding pins. If this application is required, please contact ILME SpA.

hoods with single lever



NEW

covers



NEW

description	part No.		entry		part No.	
			Pg	M	(with eyelet)	(with loop)
with lever, top entry	CZV 25 LG	16	MZV 25 LG20	20		
with pegs (for 1 lever enclosures)					CZC 25 L	CZC 25 SL
with lever (for enclosures with pegs)						CZC 25 LG

dimensions in mm

CZV LG e MZV LG

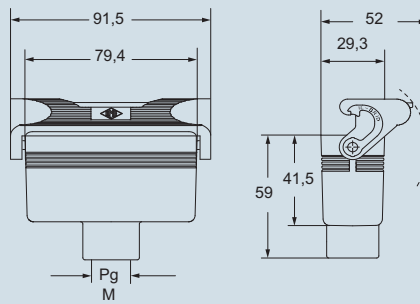

dimensions in mm

CZC L (SL)

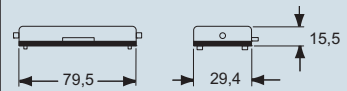

CZC LG

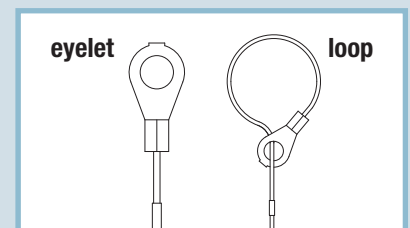
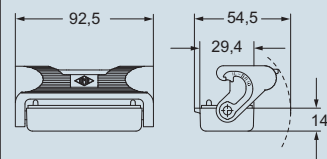

CRAUS Type 4/4X/12



dimensions shown are not binding and may be changed without notice

IL-BRID - size 66.16