

Product sheet

Miniature connector



| | | | |
|---------|--|----------------|----------------------------------|
| Product | Contacts: 14, Female panel mount connector, IP 40 | Area | Push-Pull IP67 Series 440 |
| Pole | 14 | Article number | 09 4840 25 14 |

Illustration



Scale drawing

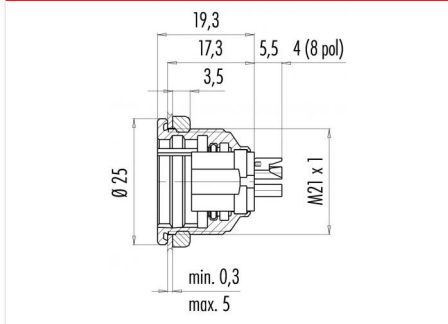

Contact Arrangement

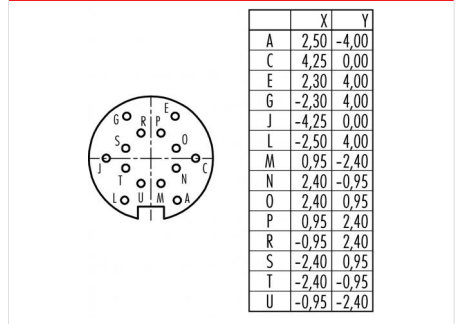

You can find the item description and assembly instruction on the next page.

Technical data

Common values

| | |
|--------------------------|------------------------------|
| Connector Design | Female panel mount connector |
| Connector locking system | Push-Pull |
| Termination | Solder |
| Wire gauge (mm) | 0.25 mm ² |
| Wire gauge (AWG) | 24 |
| Cable outlet | - |
| Upper temperature | 85 °C |
| Lower temperature | -40 °C |

Electrical values

| | |
|-----------------------|----------------------|
| Rated voltage | 60 V |
| Rated impulse voltage | 500 V |
| Pollution degree | 1 |
| Overvoltage category | I |
| Material group | III |
| Rated current (40°C) | 3 A |
| Volume resistivity | ≤ 3 mΩ |
| EMV compliance | not shielded |
| Degree of protection | IP40 |
| Mechanical operation | > 1000 mating cycles |

Material

| | |
|--------------------------|----------------------------|
| Material of contact | CuSn (Bronze) |
| Contact plating | Au (Gold) |
| Material of contact body | PBT (UL 94 V-0) |
| Material of housing | CuZn (Brass nickel-plated) |

Contacts: 14, Female panel mount connector, IP 40

Product
Pole

Contacts: 14, Female panel mount
connector, IP 40
14

Area
Article number

Push-Pull IP67 Series 440
09 4840 25 14

Item description

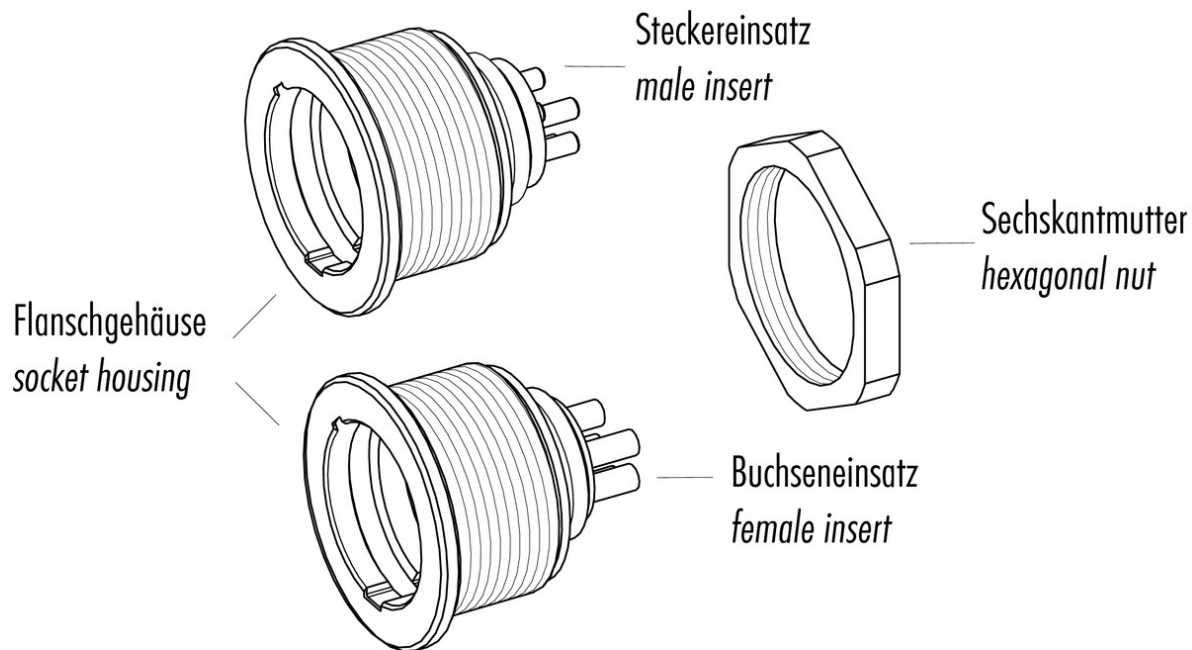

Installation instructions / Mounting cutout

