

Product	<b>Contacts: 4, Cable: 4 x 0.5 mm<sup>2</sup>, PUR, female angled connector, overmoulded</b>	Area	<b>M12-B Series 766</b>
Pole	<b>4</b>	Article number	<b>77 4434 0000 50004-0200</b>

**Illustration**

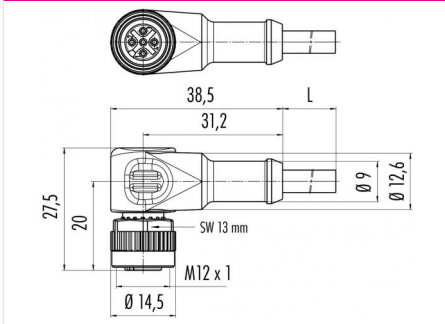

**Scale drawing**



**Contact Arrangement**

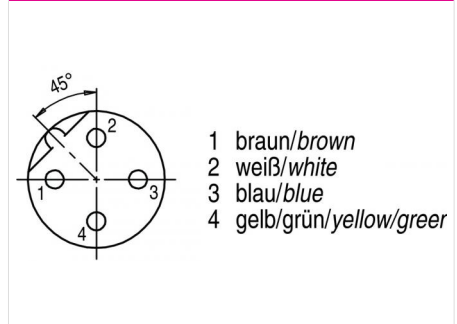

**Technical data**

**Common values**

Connector Design	Female angled connector
Connector locking system	screw
Termination	crimp, injection-moulded cable
Wire gauge (mm)	0.50 mm <sup>2</sup>
Wire gauge (AWG)	20
Upper temperature	85 °C
Lower temperature	-25 °C

**Cable data**

material housing	PUR
Insulation single lead	PVC
Single lead structure	63 x 0.1 mm
Cable sheath Ø	5.7
Conductor resistance	39 Ω/Km
Temperature range cable movable c from	-5
Temperature range cable movable c to	70
Temperature range cable fixed c from	-25
Temperature range cable fixed c to	70
Bending radius cable fixed	28 mm
Bending radius cable movable	45 mm
Cable diameter	5

**Electrical values**

Rated voltage	250 V
Rated impulse voltage	2500 V
Pollution degree	3
Overvoltage category	II
Material group	II
Rated current (40°C)	4 A
Volume resistivity	≤ 3 mΩ
EMV compliance	not shielded
Degree of protection	IP68
Mechanical operation	> 100 mating cycles

**Material**

Material of contact	CuSn (Bronze)
Contact plating	Au (Gold)
Material of contact body	PUR
Material of housing	PUR

Cable length: 4 x 0.5 mm<sup>2</sup>, Contacts: 4, Female angled connector overmoulded, cable length 2 m