

# Product sheet

## Subminiature connector



Product  
Pole

**Contacts: 7, Cable plug connector, overmoulded**  
7

Area  
Article number

**M9 IP67 Series 702**  
**79 1421 12 07**

### Illustration



### Scale drawing

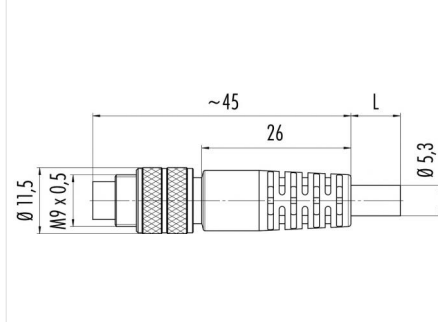

### Contact Arrangement

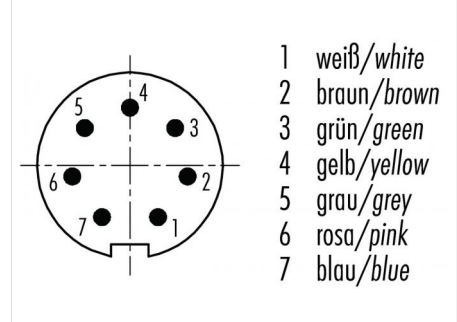

### Attenuation characteristic

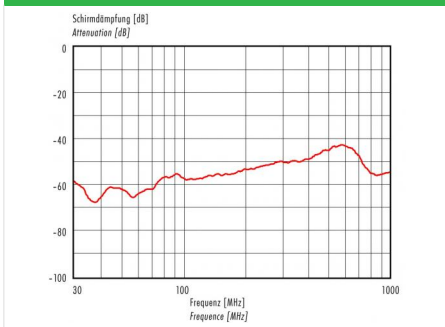

## Technical data

### Common values

Connector Design	Cable plug connector
Connector locking system	screw
Termination	overmoulded on cable
Wire gauge (mm)	0.14 mm <sup>2</sup>
Wire gauge (AWG)	26
Cable outlet	-
Upper temperature	70 °C
Lower temperature	-25 °C

### Cable data

material housing	PUR
Insulation single lead	PVC
Single lead structure	18 x 0.10 mm
Cable sheath Ø	5.3
Conductor resistance	75Ω/Km
Bending radius cable fixed	Min. 53 mm
Bending radius cable movable	Min. 80 mm
Cable diameter	5.3

### Electrical values

Rated voltage	125 V
Rated impulse voltage	1500 V
Pollution degree	1
Overvoltage category	II
Material group	III
Rated current (40°C)	1 A
Volume resistivity	≤ 3 mΩ
EMV compliance	shielded
Degree of protection	IP67
Mechanical operation	> 500 mating cycles

### Material

Material of contact	CuZn (Brass)
Contact plating	Au (Gold)
Material of contact body	PBT (UL 94 V-0)
Material of housing	PUR

**Contacts: 7, Cable plug connector overmoulded, shielded, cable length 2 m**