

Product sheet

Miniature connector



Product	Contacts: 12, Male panel mount connector, IP 67	Area	Push-Pull IP67 Series 440
Pole	12	Article number	09 4835 15 12

Illustration



Scale drawing

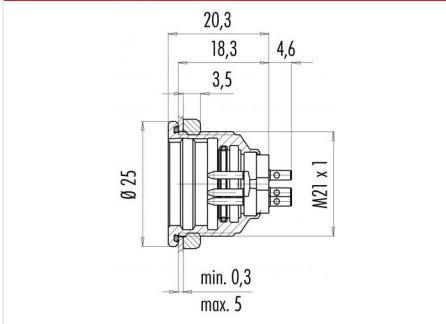

Contact Arrangement

	X	Y
A	0,41	-3,45
B	-2,29	-3,61
C	-4,10	-1,21
D	-3,20	1,34
E	-2,71	3,59
F	-0,41	3,45
G	2,29	3,61
H	4,10	1,21
J	3,20	-1,34
K	2,71	-3,59
L	-2,00	-1,51
M	2,00	1,51

You can find the item description and assembly instruction on the next page.

Technical data

Common values

Connector Design	Male panel mount connector
Connector locking system	Push-Pull
Termination	Solder
Wire gauge (mm)	0.25 mm ²
Wire gauge (AWG)	24
Cable outlet	-
Upper temperature	85 °C
Lower temperature	-40 °C

Electrical values

Rated voltage	60 V
Rated impulse voltage	500 V
Pollution degree	1
Overvoltage category	I
Material group	III
Rated current (40°C)	3 A
Volume resistivity	≤ 3 mΩ
EMV compliance	not shielded
Degree of protection	IP67
Mechanical operation	> 1000 mating cycles

Material

Material of contact	CuZn (Brass)
Contact plating	Au (Gold)
Material of contact body	PBT (UL 94 V-0)
Material of housing	CuZn (Brass nickel-plated)

Contacts: 12, Male panel mount connector, IP 67

Product
Pole

**Contacts: 12, Male panel mount connector,
IP 67
12**

Area
Article number

**Push-Pull IP67 Series 440
09 4835 15 12**

Item description

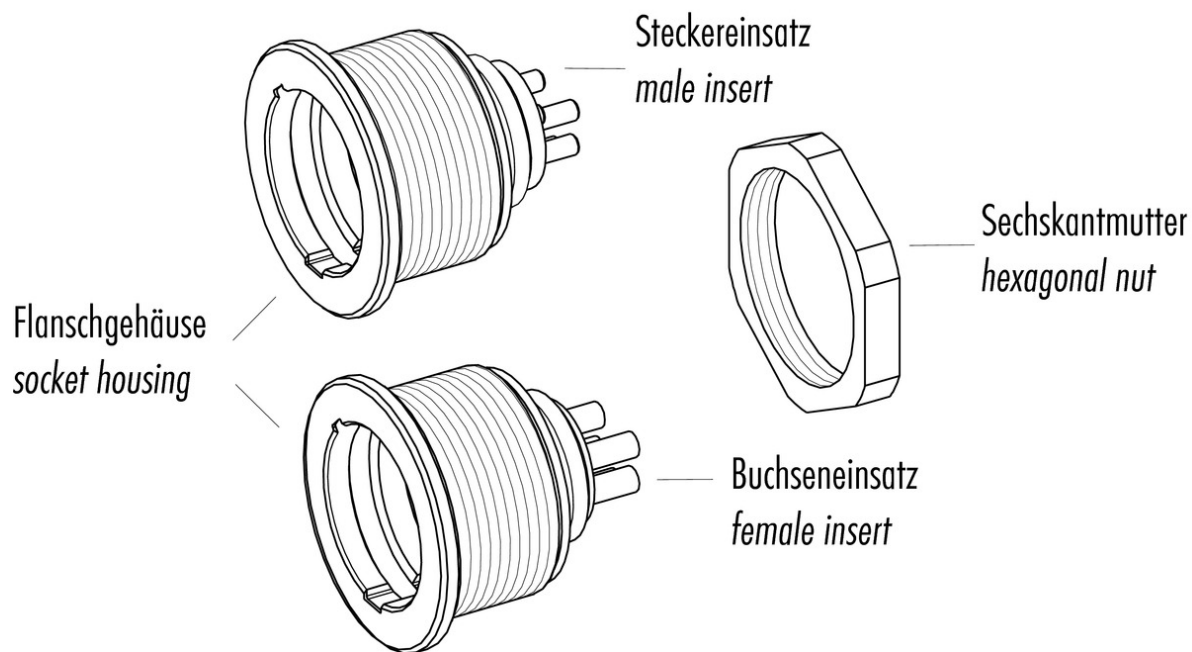

Installation instructions / Mounting cutout

