

Product sheet

Miniature connector



Product	Contacts: 8, female panel mount connector, black	Area	Snap-in IP67 Series 720
Pole	8	Article number	99 9128 00 08

Illustration



Scale drawing

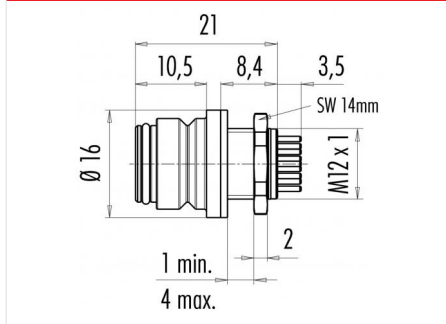

Contact Arrangement

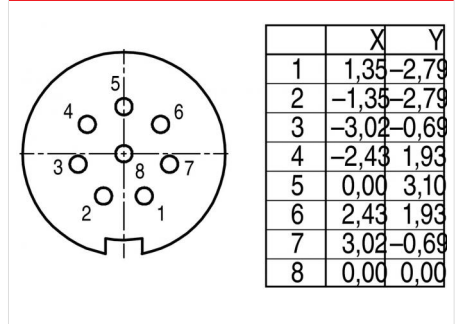

You can find the item description and assembly instruction on the next page.

Technical data

Common values

Connector Design	Female panel mount connector
Connector locking system	Snap
Termination	Solder
Wire gauge (mm)	0.25 mm ²
Wire gauge (AWG)	24
Cable outlet	-
Upper temperature	85 °C
Lower temperature	-25 °C

Electrical values

Rated voltage	125 V
Rated impulse voltage	1500 V
Pollution degree	2
Overvoltage category	II
Material group	II
Rated current (40°C)	2 A
Volume resistivity	≤ 3 mΩ
EMV compliance	not shielded
Degree of protection	IP67
Mechanical operation	> 500 mating cycles

Material

Material of contact	CuSn (Bronze)
Contact plating	Au (Gold)
Material of contact body	PA (UL 94 V-0)
Material of housing	PA (UL 94 V-0)

Contacts: 8, female panel mount connector, black

Product	Contacts: 8, female panel mount connector, black	Area	Snap-in IP67 Series 720
Pole	8	Article number	99 9128 00 08

Item description

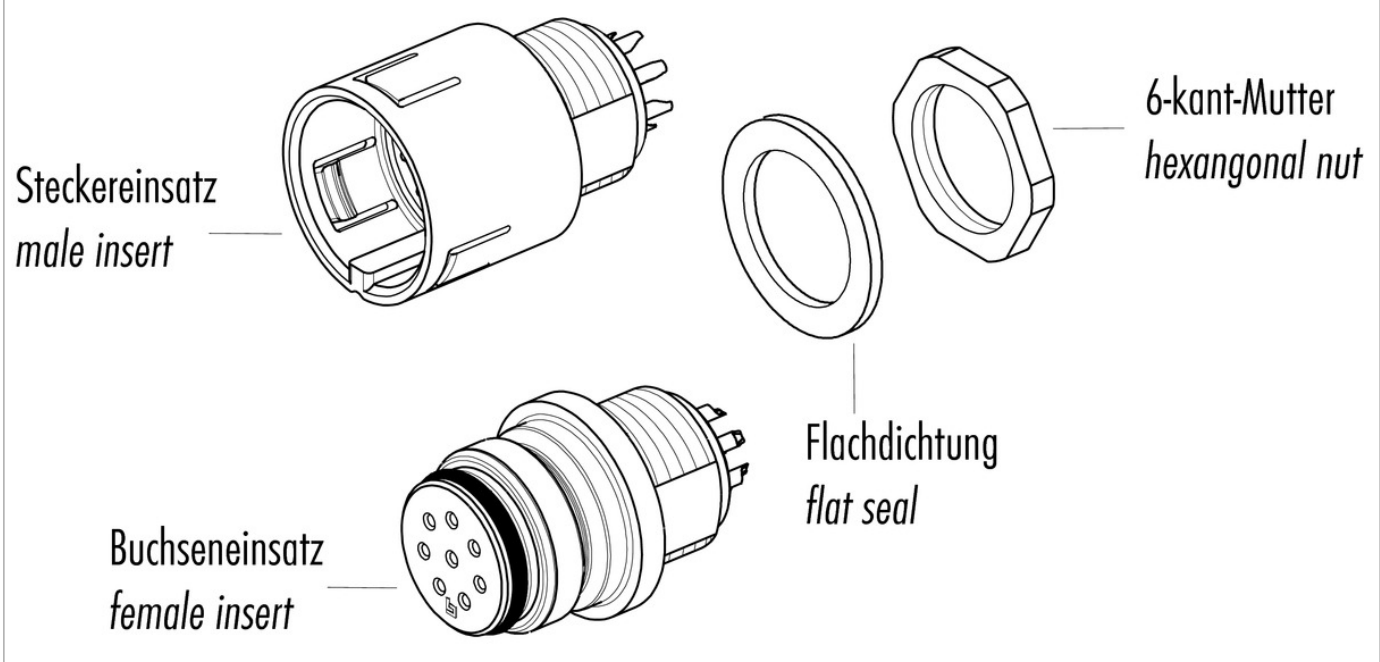

Installation instructions / Mounting cutout

