

Product sheet

Subminiature connector



Product	Contacts 8, male panel mount connector, red	Area	Snap-in IP67 Series 620
Pole	8	Article number	99 9227 050 08

Illustration



Scale drawing

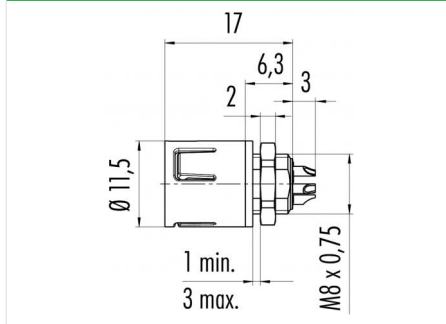

Contact Arrangement

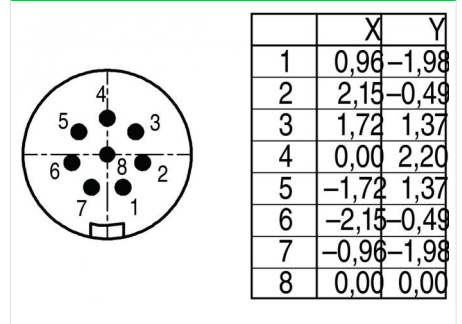

You can find the item description and assembly instruction on the next page.

Technical data

Common values

Connector Design	Male panel mount connector
Connector locking system	Snap
Wire gauge (mm)	0.25 mm ²
Wire gauge (AWG)	24
Cable outlet	3 - 5 mm
Upper temperature	85 °C
Lower temperature	-25 °C

Cable data

material housing	-
Insulation single lead	-
Single lead structure	-
Conductor resistance	-

Electrical values

Rated voltage	63 V
Rated impulse voltage	800 V
Pollution degree	2
Overvoltage category	II
Material group	II
Rated current (40°C)	1 A
Volume resistivity	≤ 3 mΩ
EMV compliance	not shielded
Degree of protection	IP67
Mechanical operation	> 500 mating cycles

Material

Material of contact	CuZn (Brass)
Contact plating	Au (Gold)
Material of contact body	PA (UL 94 V-0)
Material of housing	PA (UL 94 V-0)

Contacts: 8, male panel mount connector, red

Product	Contacts 8, male panel mount connector, red	Area	Snap-in IP67 Series 620
Pole	8	Article number	99 9227 050 08

Item description

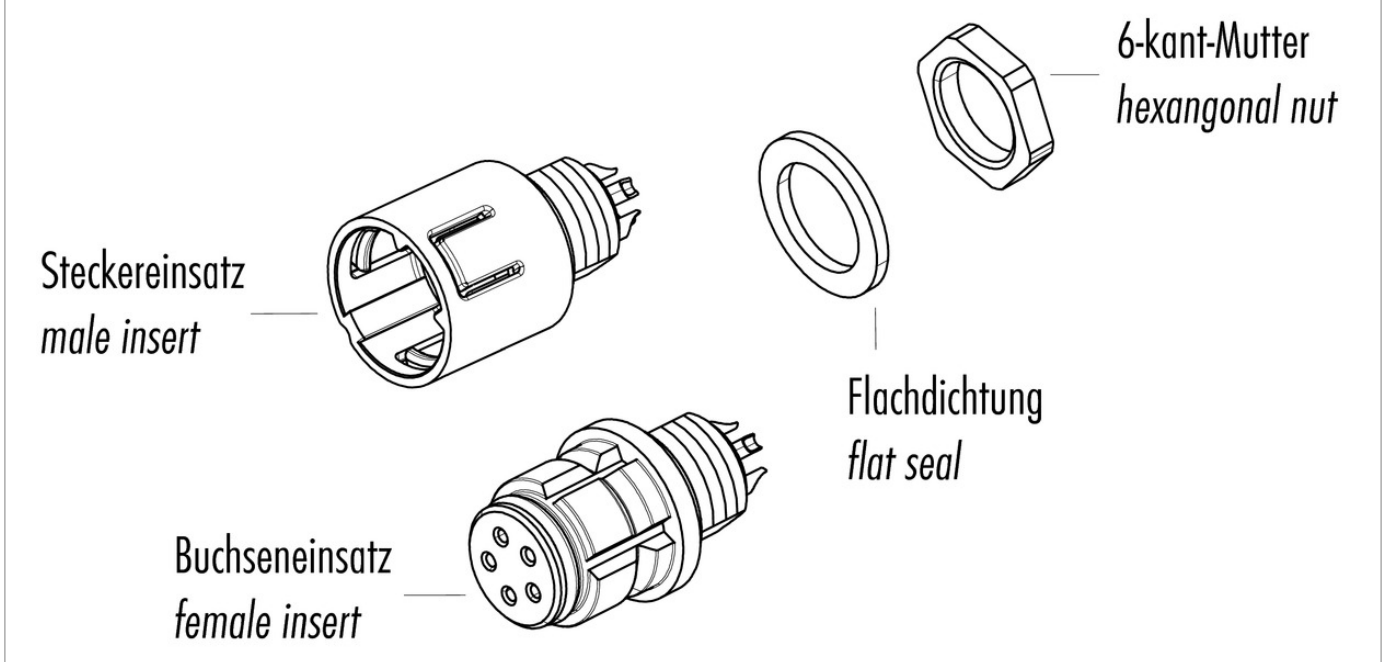

Installation instructions / Mounting cutout

