

# Product sheet

## Subminiature connector



Product  
Pole

**Contacts: 8, male angled connector  
overmoulded, unshielded**  
8

Area  
Article number

**M9 IP67 Series 702**  
**79 1461 272 08**

### Illustration



### Scale drawing

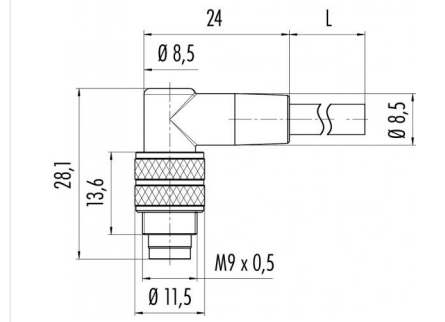

### Contact Arrangement

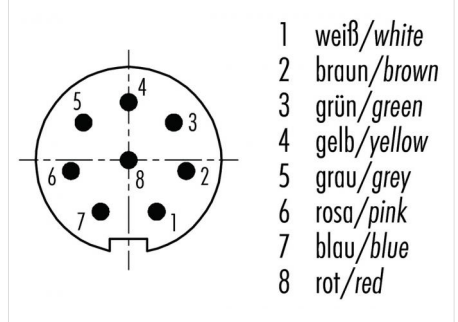

## Technical data

### Common values

Connector Design	Male angled connector
Connector locking system	screw
Termination	overmoulded on cable
Wire gauge (mm)	0.14 mm <sup>2</sup>
Wire gauge (AWG)	26
Cable outlet	-
Upper temperature	70 °C
Lower temperature	-25 °C

### Electrical values

Rated voltage	125 V
Rated impulse voltage	1500 V
Pollution degree	1
Overvoltage category	II
Material group	III
Rated current (40°C)	1 A
Volume resistivity	≤ 3 mΩ
EMV compliance	nicht geschirmt
Degree of protection	IP67
Mechanical operation	> 500 mating cycles

### Cable data

material housing	PUR
Insulation single lead	PVC/ PE
Single lead structure	18 x 0.10 mm
Cable sheath Ø	5
Conductor resistance	117Ω/Km
Temperature range cable movable c from	-5
Temperature range cable movable c to	70
Temperature range cable fixed c from	-25
Temperature range cable fixed c to	70
Bending radius cable fixed	Min. 25 mm
Bending radius cable movable	Min. 50 mm

### Material

Material of contact	CuZn (Brass)
Contact plating	Au (Gold)
Material of contact body	PBT (UL 94 V-0)
Material of housing	PUR

Contacts: 8, male angled connector overmoulded, unshielded, cable length 2 m