

Product
Pole

Contacts: 7, male panel mount connector
7

Area
Article number

M25 Power Series 691
09 0043 00 07

Illustration



Scale drawing

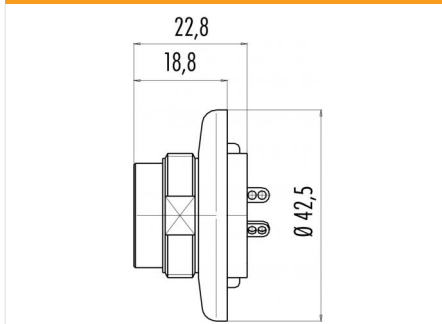

Contact Arrangement

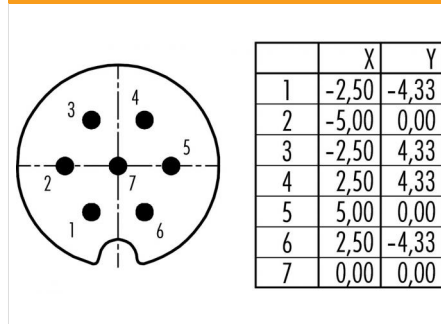

You can find the assembly instruction on the next page.

Technical data

Common values

Connector Design	Male panel mount connector
Connector locking system	screw
Termination	Solder
Wire gauge (mm)	0.75 mm ²
Wire gauge (AWG)	20
Cable outlet	-
Upper temperature	85 °C
Lower temperature	-40 °C

Electrical values

Rated voltage	250 V
Rated impulse voltage	2500 V
Pollution degree	1
Overvoltage category	II
Material group	III
Rated current (40°C)	5 A
Volume resistivity	≤ 8 mΩ
EMV compliance	not shielded
Degree of protection	IP40
Mechanical operation	> 500 mating cycles

Material

Material of contact	CuZn (Brass)
Contact plating	CuSnZn (Optaloy)
Material of contact body	PET (UL 94 V-0)
Material of housing	GD-Al (anodised)

Contacts: 7, male panel mount connector

Product
Pole

Contacts: 7, male panel mount connector
7

Area
Article number

M25 Power Series 691
09 0043 00 07

Installation instructions / Mounting cutout

