

Product sheet

Miniature connector



Product	Contacts: 8 DIN, female angled connector, cable outlet 4 - 6 mm	Area	M16 IP67 Series 723
Pole	8 DIN	Article number	99 0172 106 08

Illustration



Scale drawing

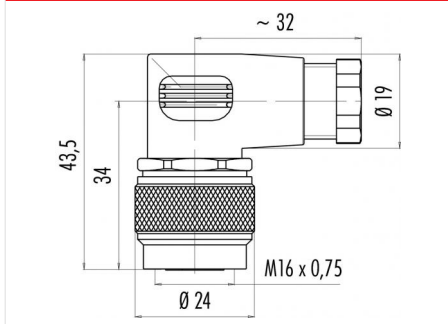

Contact Arrangement

	X	Y
1	-3,50	0,00
2	0,00	3,50
3	3,50	0,00
4	-2,47	2,47
5	2,47	2,47
6	-2,47	-2,47
7	2,47	-2,47
8	0,00	-0,70

You can find the item description on the next page.

Technical data

Common values

Connector Design	Female angled connector
Connector locking system	screw
Termination	Solder
Wire gauge (mm)	0.75 mm ²
Wire gauge (AWG)	20
Cable outlet	4 - 6 mm
Upper temperature	95 °C
Lower temperature	-40 °C

Electrical values

Rated voltage	60 V
Rated impulse voltage	500 V
Pollution degree	1
Overvoltage category	I
Material group	III
Rated current (40°C)	5 A
Volume resistivity	≤ 5 mΩ
EMV compliance	not shielded
Degree of protection	IP67
Mechanical operation	> 500 mating cycles

Material

Material of contact	CuSn (Bronze)
Contact plating	Ag (Silver)
Material of contact body	PBT (UL 94 V-0)
Material of housing	PA (UL 94 HB)

Contacts: 8 DIN, Female angled connector, cable outlet 4 - 6 mm, silver plated contacts

Product	Contacts: 8 DIN, female angled connector, cable outlet 4 - 6 mm 8 DIN	Area	M16 IP67 Series 723
Pole		Article number	99 0172 106 08

Item description

