

Product	Contacts: 4+PE, female cable connector with VDE and ETS approval	Area	RD30 Power Series 694
Pole	4+PE	Article number	99 0710 02 05

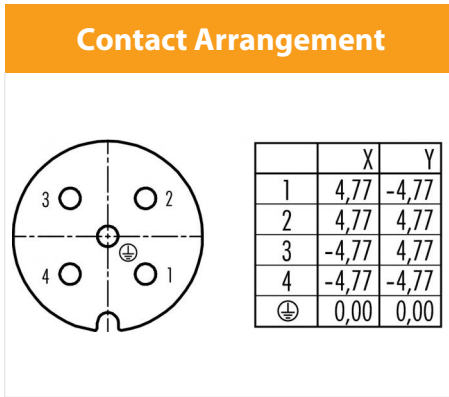
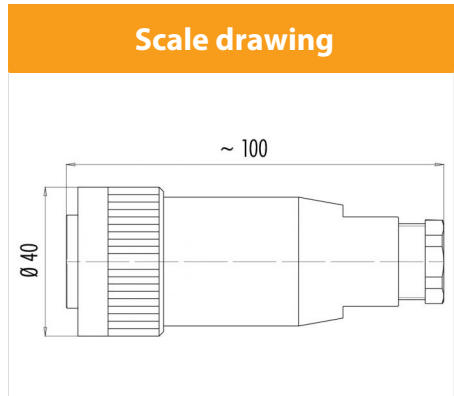
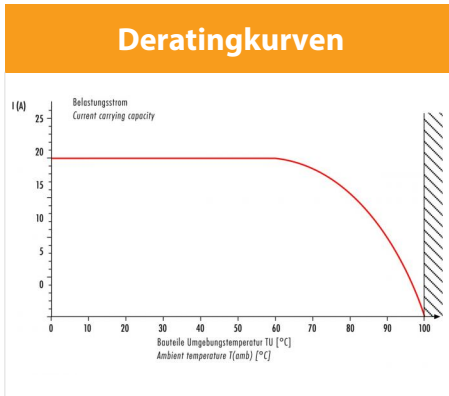

You can find the item description on the next page.

Technical data

Common values

Connector Design	Female cable connector
Connector locking system	screw
Termination	Screwing
Wire gauge (mm)	2.50 mm ²
Wire gauge (AWG)	14
Cable outlet	12 - 14 mm
Upper temperature	100 °C
Lower temperature	-40 °C

Electrical values

Rated voltage	400 V
Rated impulse voltage	6000 V
Pollution degree	3
Overvoltage category	III
Material group	III
Rated current (40°C)	20 A
Volume resistivity	≤ 5 mΩ
EMV compliance	not shielded
Degree of protection	IP65
Mechanical operation	> 500 mating cycles

Material

Material of contact	CuSn (Bronze)
Contact plating	Ag (Silver)
Material of contact body	PA (UL 94 HB)
Material of housing	PA (UL 94 V-0)

Contacts: 4+PE, female cable connector with VDE and ETS approval, cable outlet 12 - 14 mm

Product	Contacts: 4+PE, female cable connector with VDE and ETS approval	Area	RD30 Power Series 694
Pole	4+PE	Article number	99 0710 02 05

Item description

