

Product sheet

Miniature connector



Product	Contacts: 4, Female panel mount connector, IP 40	Area	Push-Pull IP67 Series 440
Pole	4	Article number	09 4812 25 04

Illustration	Scale drawing	Contact Arrangement															
		<table border="1" style="margin-left: 20px;"> <thead> <tr> <th></th> <th>X</th> <th>Y</th> </tr> </thead> <tbody> <tr> <td>1</td> <td>-3,32</td> <td>-1,08</td> </tr> <tr> <td>2</td> <td>-2,05</td> <td>2,83</td> </tr> <tr> <td>3</td> <td>2,05</td> <td>2,83</td> </tr> <tr> <td>4</td> <td>3,32</td> <td>-1,08</td> </tr> </tbody> </table>		X	Y	1	-3,32	-1,08	2	-2,05	2,83	3	2,05	2,83	4	3,32	-1,08
	X	Y															
1	-3,32	-1,08															
2	-2,05	2,83															
3	2,05	2,83															
4	3,32	-1,08															

You can find the item description and assembly instruction on the next page.

Technical data

Common values

Connector Design	Female panel mount connector
Connector locking system	Push-Pull
Termination	Solder
Wire gauge (mm)	0.75 mm ²
Wire gauge (AWG)	20
Cable outlet	-
Upper temperature	85 °C
Lower temperature	-40 °C

Electrical values

Rated voltage	250 V
Rated impulse voltage	1500 V
Pollution degree	1
Overvoltage category	I
Material group	III
Rated current (40°C)	6 A
Volume resistivity	≤ 3 mΩ
EMV compliance	not shielded
Degree of protection	IP40
Mechanical operation	> 1000 mating cycles

Material

Material of contact	CuSn (Bronze)
Contact plating	Au (Gold)
Material of contact body	PBT (UL 94 V-0)
Material of housing	CuZn (Brass nickel-plated)

Contacts: 4, Female panel mount connector, IP 40

Product

Contacts: 4, Female panel mount connector, IP 40
4

Area
Article number

Push-Pull IP67 Series 440
09 4812 25 04

Pole

Item description

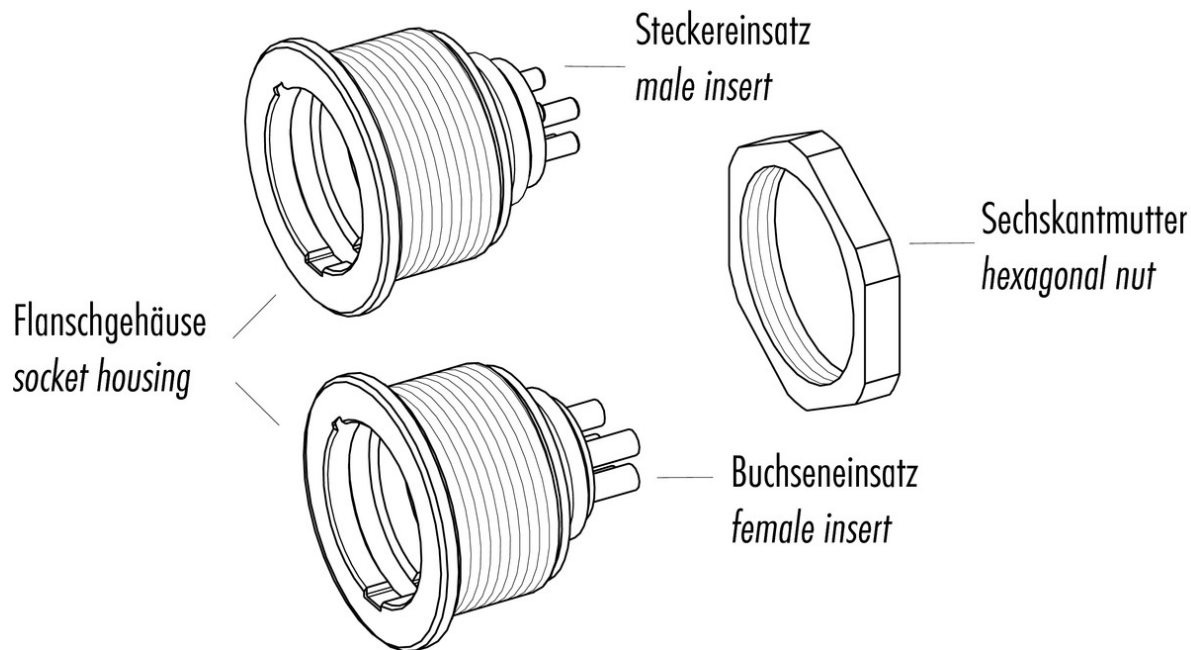

Installation instructions / Mounting cutout

