

# Product sheet

## Miniature connector



Product	<b>Contacts: 19, female panel mount connector, screwed from front, IP 67</b>	Area	<b>Push-Pull IP67 Series 440</b>
Pole	<b>19</b>	Article number	<b>09 4844 80 19</b>

### Illustration



### Scale drawing

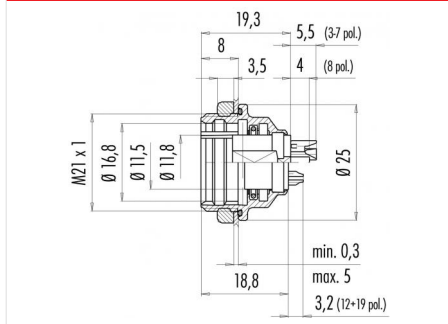

### Contact Arrangement

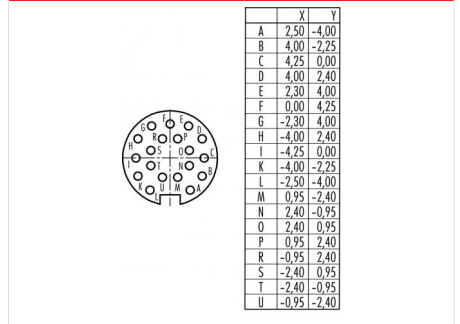

You can find the item description and assembly instruction on the next page.

## Technical data

### Common values

Connector Design	Female panel mount connector
Connector locking system	Push-Pull
Termination	Solder
Wire gauge (mm)	0.25 mm <sup>2</sup>
Wire gauge (AWG)	24
Cable outlet	-
Upper temperature	85 °C
Lower temperature	-40 °C

### Electrical values

Rated voltage	60 V
Rated impulse voltage	500 V
Pollution degree	1
Overvoltage category	I
Material group	III
Rated current (40°C)	3 A
Volume resistivity	≤ 3 mΩ
EMV compliance	not shielded
Degree of protection	IP67
Mechanical operation	> 1000 mating cycles

### Material

Material of contact	CuSn (Bronze)
Contact plating	Au (Gold)
Material of contact body	PBT (UL 94 V-0)
Material of housing	CuZn (Brass nickel-plated)

Contacts: 19, female panel mount connector, screwed from front, IP 67

Product

Contacts: 19, female panel mount connector, screwed from front, IP 67 19

Area Article number

Push-Pull IP67 Series 440 09 4844 80 19

Pole

Item description

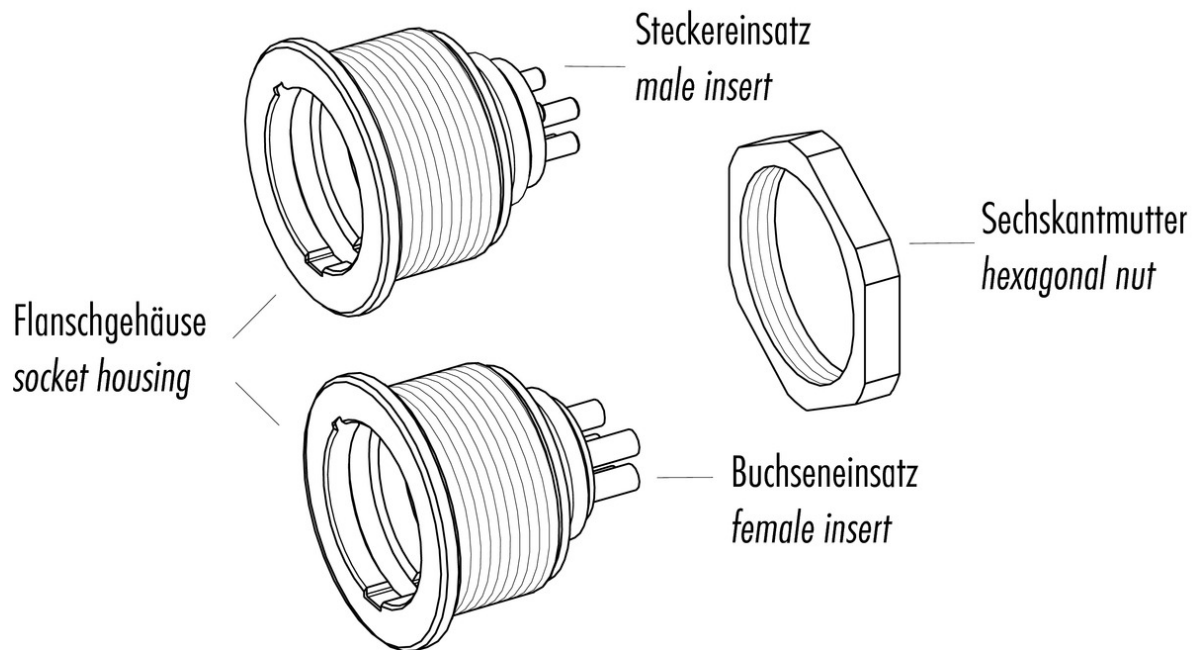

Installation instructions / Mounting cutout

