

Product	<b>Contacts: 2+PE, female angled connector with UL approval, cable outlet 8 - 10 mm, 10 - 12 mm</b>	Area	<b>7/8" Series 820</b>
Pole	<b>2+PE</b>	Article number	<b>99 2440 62 03</b>

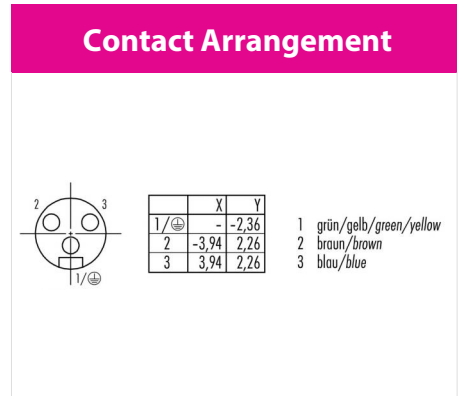
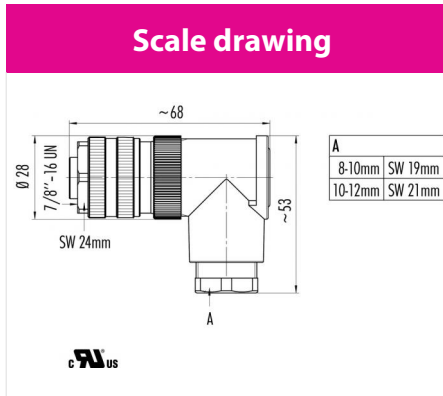

You can find the item description and assembly instruction on the next page.

## Technical data

### Common values

Connector Design	Female angled connector
Connector locking system	Screws 7/8" - 16 UN
Termination	Screwing
Wire gauge (mm)	1.50 mm <sup>2</sup>
Wire gauge (AWG)	16
Cable outlet	8 - 10 mm
Upper temperature	85 °C
Lower temperature	-25 °C

### Electrical values

Rated voltage	300 V
Rated impulse voltage	4000 V
Pollution degree	3
Overvoltage category	III
Material group	III
Rated current (40°C)	12 A
Volume resistivity	≤ 3 mΩ
Degree of protection	IP67
Mechanical operation	> 50 mating cycles

### Cable data

material housing	-
Insulation single lead	-
Single lead structure	-
Conductor resistance	-
Bending radius cable fixed	-
Bending radius cable movable	-

### Material

Material of contact	CuZn (Brass)
Contact plating	Au (Gold)
Material of contact body	PUR, PA (UL 94 HB)
Material of housing	PBT (UL 94 V-0)

cable outlet: 8 – 10 mm, Contacts: 2+PE, female angled connector with UL approval, cross-section 1.5 mm<sup>2</sup>

Product	<b>Contacts: 2+PE, female angled connector with UL approval, cable outlet 8 - 10 mm, 10 - 12 mm</b>	Area	<b>7/8" Series 820</b>
Pole	<b>2+PE</b>	Article number	<b>99 2440 62 03</b>

Item description

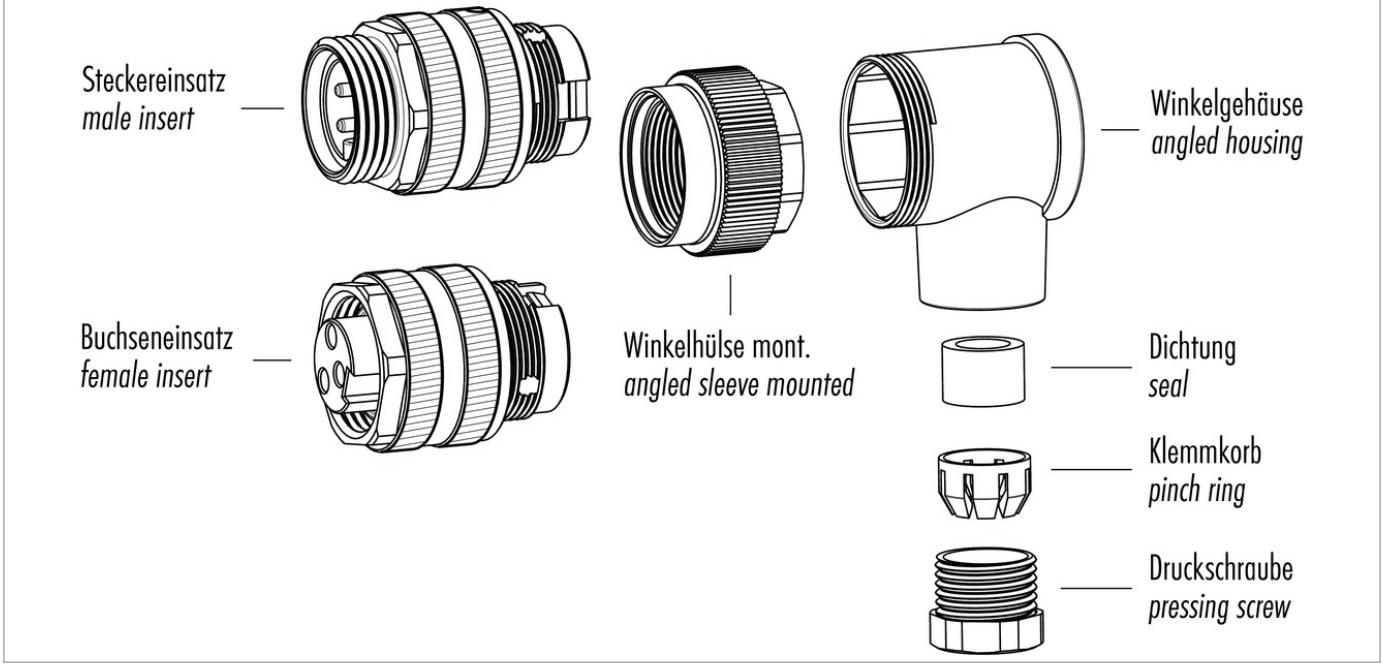

Installation instructions / Mounting cutout

