

Product	Contacts: 4, Male panel mount connector, screwed from front, dip-soldered, PG 9	Area	M12-B Series 715/766
Pole	4	Article number	09 4431 90 04

Illustration

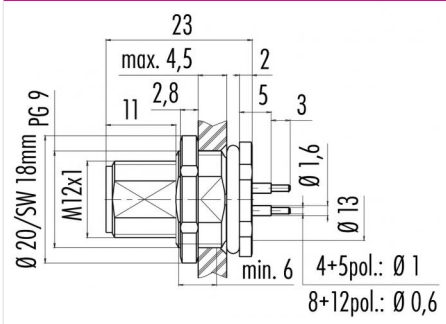

Scale drawing



Contact Arrangement

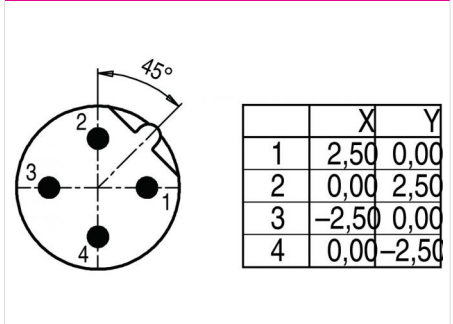

You can find the assembly instruction on the next page.

Technical data

Common values

Connector Design	Male panel mount connector
Connector locking system	screw
Termination	dip-solder
Wire gauge (mm)	-
Wire gauge (AWG)	-
Upper temperature	85 °C
Lower temperature	-40 °C

Electrical values

Rated voltage	250 V
Rated impulse voltage	2500 V
Pollution degree	3
Overvoltage category	II
Material group	II
Rated current (40°C)	4 A
Volume resistivity	≤ 3 mΩ
EMV compliance	not shielded
Degree of protection	IP68
Mechanical operation	> 100 mating cycles

Cable data

material housing	-
Insulation single lead	-
Single lead structure	-
Conductor resistance	-
Bending radius cable fixed	-
Bending radius cable movable	-

Material

Material of contact	CuZn (Brass)
Contact plating	Au (Gold)
Material of contact body	PA
Material of housing	Brass, nickel-plated zinc die casting

Contacts: 4, Male panel mount connector, screwed from front, dip-solder

Product	Contacts: 4, Male panel mount connector, screwed from front, dip-soldered, PG 9	Area	M12-B Series 715/766
Pole	4	Article number	09 4431 90 04

Installation instructions / Mounting cutout

Mit Fläche als Verdrehschutz
With flats as anti-rotation device

Mit Durchgangsbohrung
With bore hole

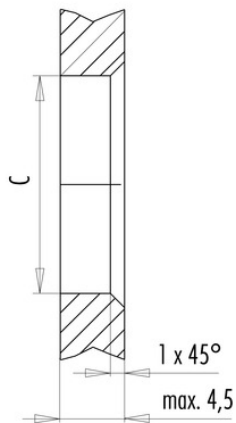
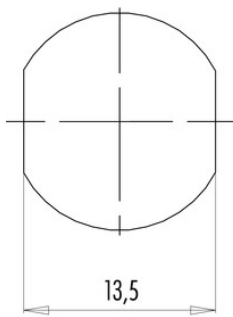

	C
PG 9	15,3
M16x1,5	16,1

Anzugsdrehmoment/Tightening moment

Metallgehäuse/Metal housing 6,25 Nm
Kunststoffgehäuse/Plastic housing 3,75 Nm