

Product sheet

Miniature connector



Product	Contacts: 19, female angled connector, cable outlet 6 - 8 mm	Area	M16 IP67 Series 723
Pole	19	Article number	99 0462 75 19

Illustration



Scale drawing

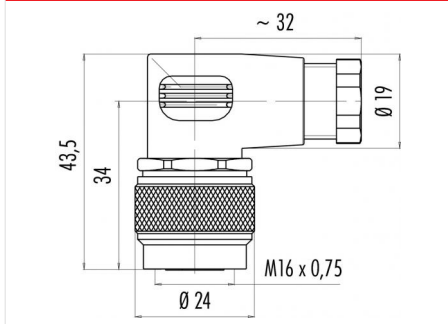

Contact Arrangement

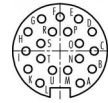

	X	Y
A	2,50	-4,00
B	4,00	-2,25
C	4,25	0,00
D	4,00	2,40
E	2,30	4,00
F	0,00	4,25
G	-2,30	4,00
H	-4,00	2,40
I	-4,25	0,00
K	-4,00	-2,25
L	-2,50	-4,00
M	0,95	-2,40
N	2,40	-0,95
O	2,40	0,95
P	0,95	2,40
R	-0,95	2,40
S	-2,40	0,95
T	-2,40	-0,95
U	-0,95	-2,40

You can find the item description on the next page.

Technical data

Common values

Connector Design	Female angled connector
Connector locking system	screw
Termination	Solder
Wire gauge (mm)	0.25 mm ²
Wire gauge (AWG)	24
Cable outlet	6 - 8 mm
Upper temperature	95 °C
Lower temperature	-40 °C

Electrical values

Rated voltage	60 V
Rated impulse voltage	500 V
Pollution degree	1
Overvoltage category	I
Material group	III
Rated current (40°C)	3 A
Volume resistivity	≤ 3 mΩ
EMV compliance	not shielded
Degree of protection	IP67
Mechanical operation	> 500 mating cycles

Material

Material of contact	CuSn (Bronze)
Contact plating	Au (Gold)
Material of contact body	PBT (UL 94 V-0)
Material of housing	PA (UL 94 HB)

Contacts: 19, Female angled connector, cable outlet 6 - 8 mm, gold plated contacts

Product	Contacts: 19, female angled connector, cable outlet 6 - 8 mm	Area	M16 IP67 Series 723
Pole	19	Article number	99 0462 75 19

Item description

