

Product sheet

Miniature connector



Product	Contacts: 16, female cable connector, cable outlet 3 - 6 mm	Area	M16 IP40 Series 680
Pole	16	Article number	09 0338 00 16

Illustration



Scale drawing

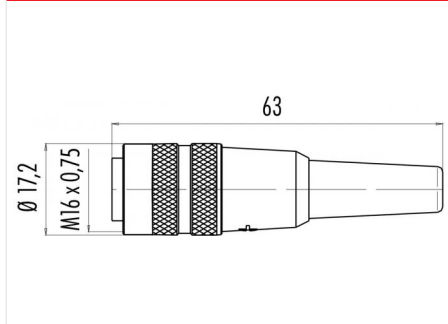

Contact Arrangement

	X	Y
A	2,50	-4,00
B	4,00	-2,25
C	4,25	0,00
D	4,00	2,40
E	2,30	4,00
F	0,00	4,25
G	-2,30	4,00
H	-4,00	2,40
I	-4,25	0,00
K	-4,00	-2,25
L	-2,50	-4,00
M	0,00	-2,60
N	2,45	-0,80
O	1,50	2,10
P	-1,50	2,10
R	-2,40	-0,80

You can find the item description on the next page.

Technical data

Common values

Connector Design	Female cable connector
Connector locking system	screw
Termination	Solder
Wire gauge (mm)	0.25 mm ²
Wire gauge (AWG)	24
Cable outlet	3 - 6 mm
Upper temperature	85 °C
Lower temperature	-40 °C

Electrical values

Rated voltage	60 V
Rated impulse voltage	500 V
Pollution degree	1
Overvoltage category	I
Material group	III
Rated current (40°C)	3 A
Volume resistivity	≤ 3 mΩ
EMV compliance	not shielded
Degree of protection	IP40
Mechanical operation	> 500 mating cycles

Material

Material of contact	CuSn (Bronze)
Contact plating	Au (Gold)
Material of contact body	PBT (UL 94 V-0)
Material of housing	PA (UL 94 HB)

Contacts: 16, female cable connector, cable outlet 3 - 6 mm, gold plated contacts

Product	Contacts: 16, female cable connector, cable outlet 3 - 6 mm	Area	M16 IP40 Series 680
Pole	16	Article number	09 0338 00 16

Item description

