

Product **connecting cable, overmoulded, F&B, stainless steel,PVC grey**
 Area **M12-A Series 763 FOOD & BEVERAGE**
 Article number **77 3730 3727 20912-0200**

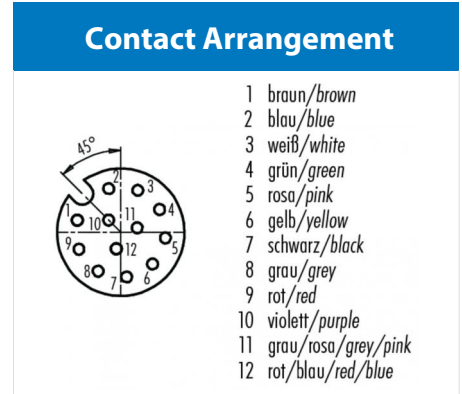
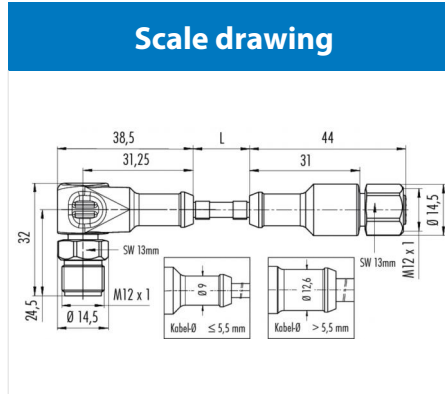

Technical data

General features

Connector Design	Cable Connector
Connector locking system	screw
Termination	crimp, overmoulded on cable
Wire gauge (mm)	0,25
Wire gauge (AWG)	24
Upper temperature	105 °C
Lower temperature	-40 °C

Cable data

material housing	PVC
Insulation single lead	PVC
Single lead structure	32 x 0,1
Cable sheath Ø	6,6
Conductor resistance	75 Ω/Km (20°C)
Temperature range cable movable °C from	-5
Temperature range cable movable °C to	105
Temperature range cable fixed °C from	-40
Temperature range cable fixed °C to	105
Bending radius cable fixed	min. 5 x D
Bending radius cable movable	min. 10 x D
Approval 1	UL listed
Approval 2	Ecolab

Electrical parameters

Rated voltage	30 V
Rated impulse voltage	800 V
Pollution degree	3
Overvoltage category	II
Material group	II
Rated current (40°C)	1,5 A
Volume resistivity	≤ 3 mΩ
EMV compliance	not shielded
Degree of protection	IP69K
Mechanical operation	> 100 Mating cycles

Material

Material of contact	CuSn (Bronze)
Contact plating	Au (gold)
Material of contact body	PP
Material of housing	PP