

Product	Contacts: 5, Cable: 5 x 0.5 mm², PUR, male angled connector, overmoulded	Area	M12-B Series 766
Pole	5	Article number	77 4427 0000 50005-0500

Illustration

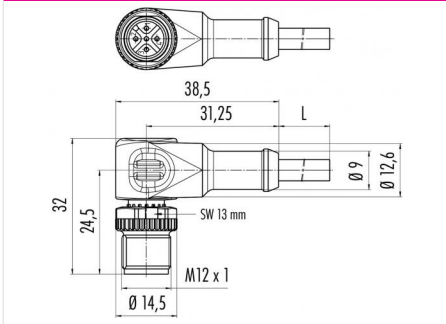

Scale drawing



Contact Arrangement

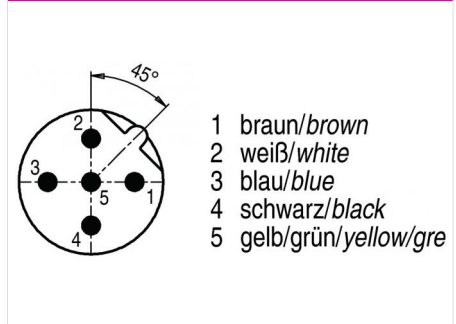

Technical data

Common values

Connector Design	Male angled connector
Connector locking system	screw
Termination	crimp, injection-moulded cable
Wire gauge (mm)	0.50 mm ²
Wire gauge (AWG)	20
Upper temperature	85 °C
Lower temperature	-25 °C

Cable data

material housing	PUR
Insulation single lead	PVC
Single lead structure	63 x 0.1 mm
Cable sheath Ø	5.7
Conductor resistance	39 Ω/Km
Temperature range cable movable c from	-5
Temperature range cable movable c to	70
Temperature range cable fixed c from	-25
Temperature range cable fixed c to	70
Bending radius cable fixed	28 mm
Bending radius cable movable	45 mm
Cable diameter	5.7

Electrical values

Rated voltage	125 V
Rated impulse voltage	1500 V
Pollution degree	3
Overvoltage category	II
Material group	II
Rated current (40°C)	4 A
Volume resistivity	≤ 3 mΩ
EMV compliance	not shielded
Degree of protection	IP68
Mechanical operation	> 100 mating cycles

Material

Material of contact	CuZn (Brass)
Contact plating	Au (Gold)
Material of contact body	PUR
Material of housing	PUR

Cable length: 5 x 0.5 mm², Contacts: 5, Male angled connector overmoulded, cable length 5 m