

Product sheet
Miniature connector



Product	Contacts: 7, Female panel mount connector, IP 67, shielded	Area	Push-Pull IP67 Series 440
Pole	7	Article number	09 4828 00 07

Illustration



Scale drawing

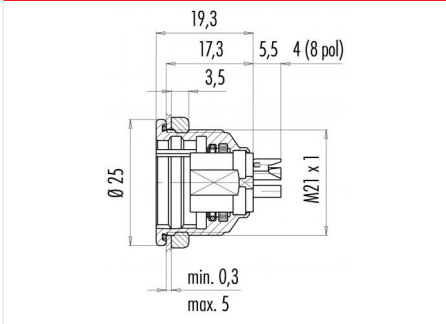

Contact Arrangement

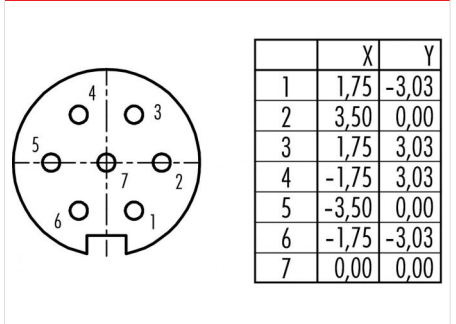

You can find the item description and assembly instruction on the next page.

Technical data

Common values

Connector Design	Female panel mount connector
Connector locking system	Push-Pull
Termination	Solder
Wire gauge (mm)	0.75 mm ²
Wire gauge (AWG)	20
Cable outlet	-
Upper temperature	85 °C
Lower temperature	-40 °C

Electrical values

Rated voltage	125 V
Rated impulse voltage	800 V
Pollution degree	1
Overvoltage category	I
Material group	III
Rated current (40°C)	5 A
Volume resistivity	≤ 3 mΩ
EMV compliance	shielded
Degree of protection	IP67
Mechanical operation	> 1000 mating cycles

Material

Material of contact	CuSn (Bronze)
Contact plating	Au (Gold)
Material of contact body	PBT (UL 94 V-0)
Material of housing	CuZn (Brass nickel-plated)

Contacts: 7, Female panel mount connector, IP 67, shielded

Product	Contacts: 7, Female panel mount connector, IP 67, shielded	Area	Push-Pull IP67 Series 440
Pole	7	Article number	09 4828 00 07

Item description

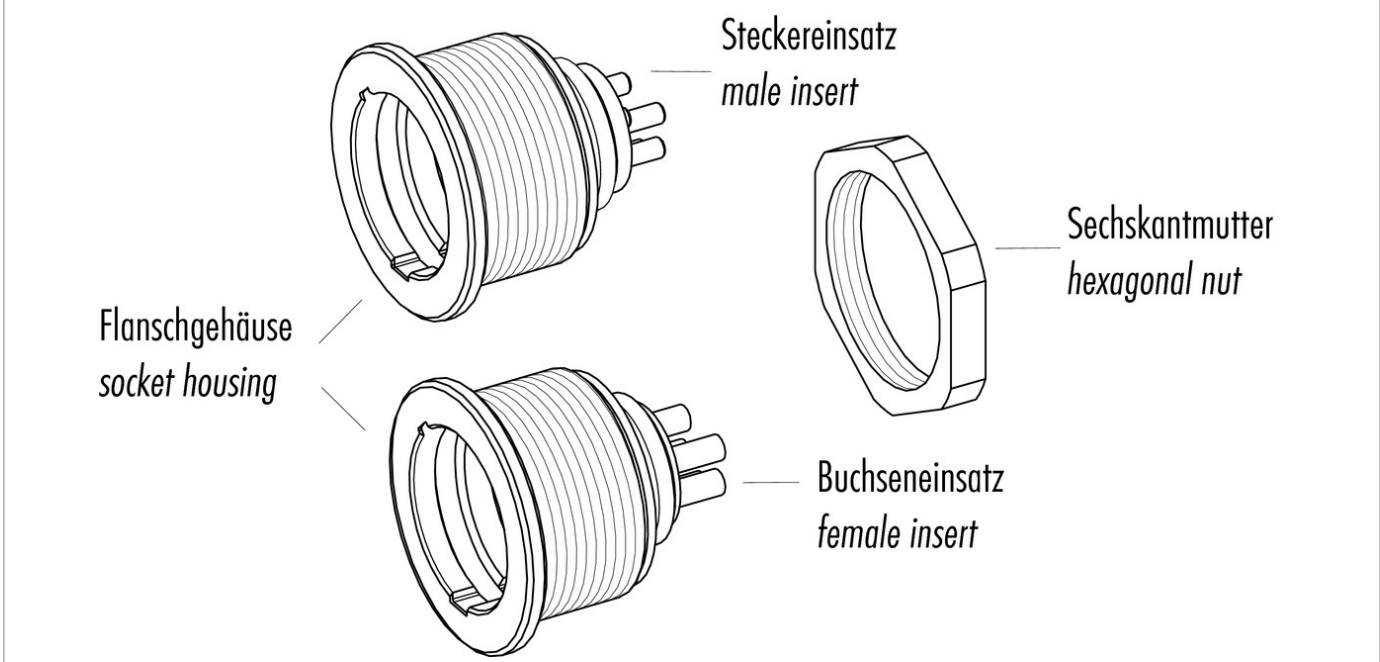

Installation instructions / Mounting cutout

