

Product	Contacts: 4/3, Double distributor, male connector M8x1 - 2 female connectors M8x1, with fastening bores	Area	Connecting cords Series 765
Pole	4/3	Article number	79 5232 70 04

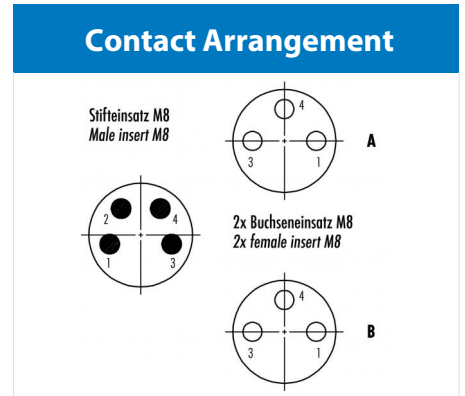
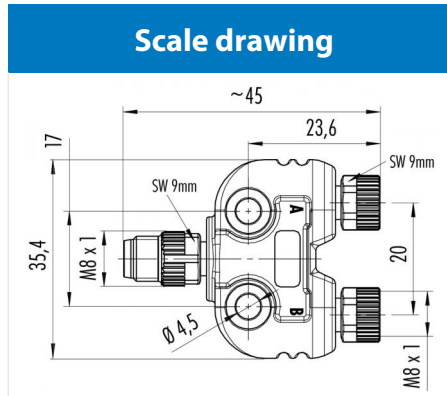

Technical data

Common values

Connector Design	Dual distributor
Connector locking system	screw
Upper temperature	85 °C
Lower temperature	-25 °C

Electrical values

Rated voltage	60 V
Rated impulse voltage	1500 V
Pollution degree	3
Overvoltage category	II
Material group	II
Rated current (40°C)	4 A
Volume resistivity	≤ 3 mΩ
EMV compliance	nicht geschirmt
Degree of protection	IP67
Mechanical operation	> 100 mating cycles

Material

Material of contact	Pin/ CuZn (brass), socket/ CuSn (bronze)
Contact plating	Au (Gold)
Material of contact body	PUR
Material of housing	PUR

Contacts: 4/3, Double distributor, male connector M8x1 - 2 female connectors M8x1, with fastening bores