

Product	Contacts: 5, female cable connector, green
Area	Snap-in IP67, subminiature Series
Article number	99 9214 470 05

Illustration

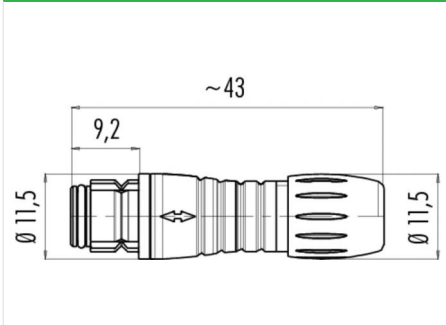

Scale drawing



Contact Arrangement

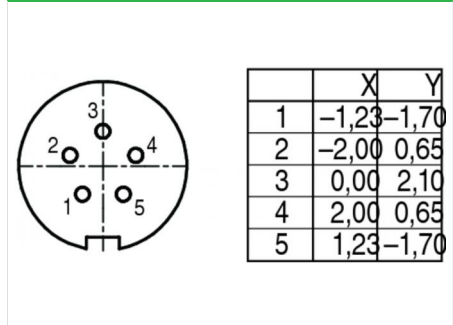

You can find the item description on the next page.

Technical data

General features

Connector Design	Cable socket
Connector locking system	snap
Termination	solder
Wire gauge (mm)	0,25 mm ²
Wire gauge (AWG)	24
Cable outlet	3 - 5 mm
Upper temperature	85 °C
Lower temperature	-25 °C

Electrical parameters

Rated voltage	63 V
Rated impulse voltage	800 V
Pollution degree	2
Overvoltage category	II
Material group	II
Rated current (40°C)	2 A
Volume resistivity	≤ 3 mΩ
EMV compliance	not shielded
Degree of protection	IP67

Material

Material of contact	CuSn (Bronze)
Contact plating	Au (gold)
Material of contact body	PA (UL 94 V-0)

Product **Contacts: 5, female cable connector, green**

Area **Snap-in IP67, subminiature Series**
Article number **99 9214 470 05**

Item description

