

Product **423/723/425: Protection cap for female panel mount connector, IP67**
 Article number **08 1080 000 000**

Illustration

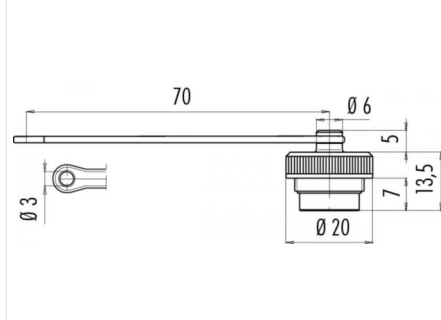

Scale drawing



Matching products

- Female panel mount connector with mass contact
- Female panel mount connector, solder, 2 - 8 contacts, with UL approval
- Female panel mount connector, solder, 12 - 19 contacts, with UL approval
- Female panel mount connector, solder, 24 contacts, with UL approval
- Female panel mount connector, solder, screwed from front, 2 - 8 contacts, with UL approval
- Female panel mount connector, solder, screwed from front, 12 - 19 contacts, with UL approval
- Female panel mount connector, solder, screwed from front, 24 contacts, with UL approval
- Female panel mount connector, dip-solder, screwed from front, 2 - 8 contacts, with UL approval
- Female panel mount connector, dip-solder, screwed from front, 12 - 19 contacts, with UL approval
- Female panel mount connector, dip-solder, screwed from front, 24 contacts, with UL approval
- Female panel mount connector, crimp
- Female panel mount connector, crimp, screwed from front
- Female panel mount connector with flexible plate, contacts 7, screwed from front, silver plated contacts
- Female panel mount connector with flexible plate, contacts 8 DIN, screwed from front, silver plated contacts
- Female panel mount connector with flexible plate, contacts 12, screwed from front, gold plated contacts, single row
- Female panel mount connector with flexible plate, contacts 12, screwed from front, gold plated contacts, double-row