

Product	Contacts: 4, Female cable connector, shieldable, screw terminal connection, static ring version, with UL approval	Area	M12-A Series 713
Pole	4	Article number	99 1430 812 04

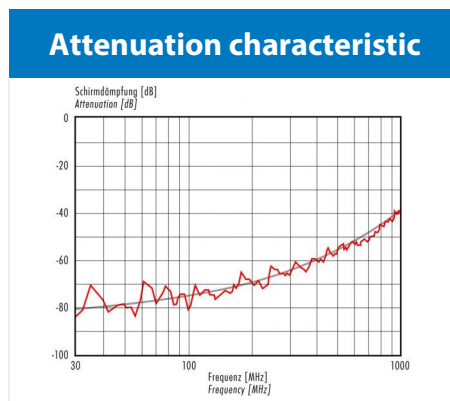
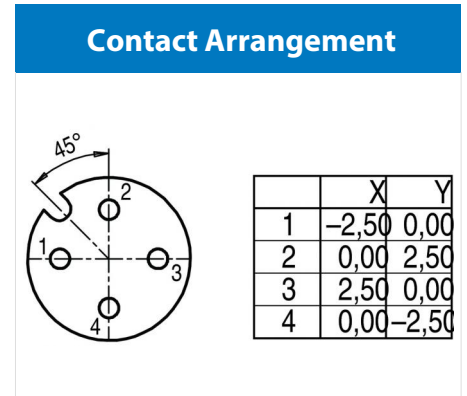
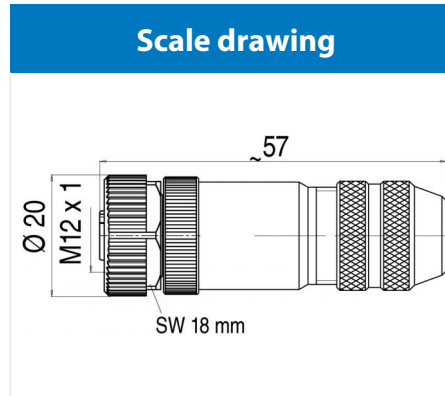

You can find the item description and assembly instruction on the next page.

Technical data

Common values

Connector Design	Female cable connector
Connector locking system	screw
Termination	Screwing
Wire gauge (mm)	0.75 mm ²
Wire gauge (AWG)	18
Cable outlet	6 - 8 mm
Upper temperature	85 °C
Lower temperature	-40 °C

Electrical values

Rated voltage	250 V
Rated impulse voltage	2500 V
Pollution degree	3
Overvoltage category	II
Material group	II
Rated current (40°C)	4 A
Volume resistivity	≤ 3 mΩ
EMV compliance	shielded
Degree of protection	IP67
Mechanical operation	> 100 mating cycles

Material

Material of contact	CuZn (Brass)
Contact plating	Au (Gold)
Material of contact body	PA
Material of housing	Nickel-plated zinc die casting

Contacts: 4, Cable outlet: 6-8 mm, female cable connector, shieldable, screw terminal connection, static ring version with die-cast threaded ring, with UL approval

Product	Contacts: 4, Female cable connector, shieldable, screw terminal connection, static ring version, with UL approval	Area	M12-A Series 713
Pole	4	Article number	99 1430 812 04

Item description

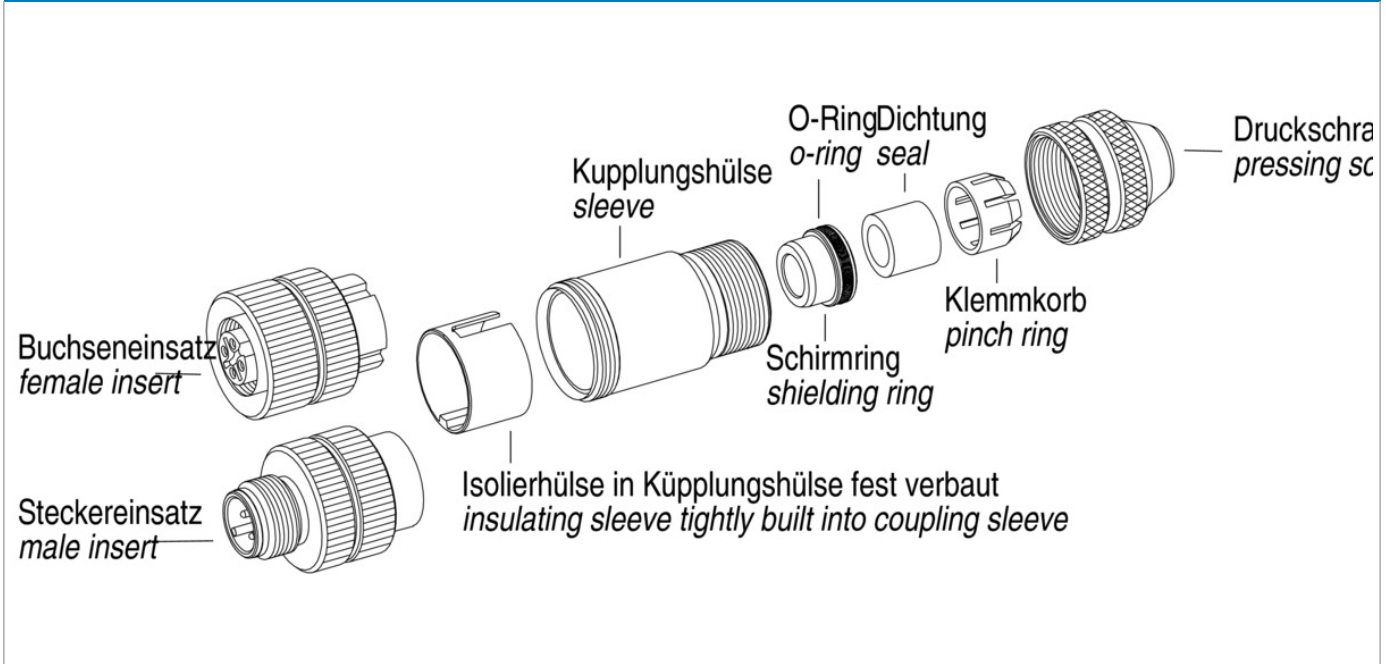

Installation instructions / Mounting cutout

	Schraubklemmversion screw connection	Lötversion solder version	Käfigzugfederversion wire clamp connection
Maß A/mm measure A/mm	5	3,5	7