

Product sheet

Miniature connector



Product	Contacts: 19, Male panel mount connector, dip-solder, screwed from front	Area	M16 IP40 Series 581/ 680/ 682
Pole	19	Article number	09 0335 90 19

Illustration



Scale drawing

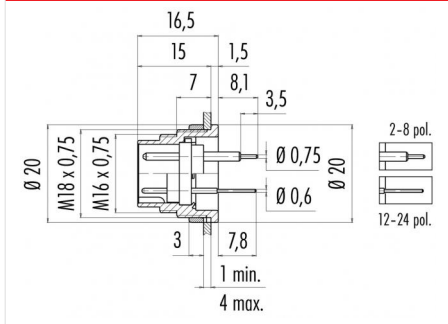

Contact Arrangement

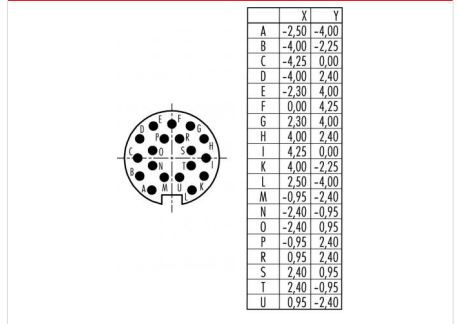

You can find the assembly instruction on the next page.

Technical data

Common values

Connector Design	Male panel mount connector
Connector locking system	screw
Termination	dip-solder
Wire gauge (mm)	-
Wire gauge (AWG)	-
Upper temperature	85 °C
Lower temperature	-40 °C

Electrical values

Rated voltage	60 V
Rated impulse voltage	500 V
Pollution degree	1
Overvoltage category	I
Material group	III
Rated current (40°C)	3 A
Volume resistivity	≤ 3 mΩ
EMV compliance	shielded
Degree of protection	IP40
Mechanical operation	> 500 mating cycles

Material

Material of contact	CuZn (Brass)
Contact plating	Au (Gold)
Material of contact body	PBT (UL 94 V-0)
Material of housing	Nickel-plated zinc die casting

Contacts: 19, Male panel mount connector, dip-solder, screwed from front, gold plated contacts

Product

Contacts: 19, Male panel mount connector,
dip-solder, screwed from front
19

Area
Article number

M16 IP40 Series 581/ 680/ 682
09 0335 90 19

Pole

Installation instructions / Mounting cutout

