

Product	Contacts 4: Connecting cord, cable plug connector, female angled connector, M8x1, 4x0.25 PUR	Area	Connecting cords Series 765
Pole	4	Article number	79 5037 20 04

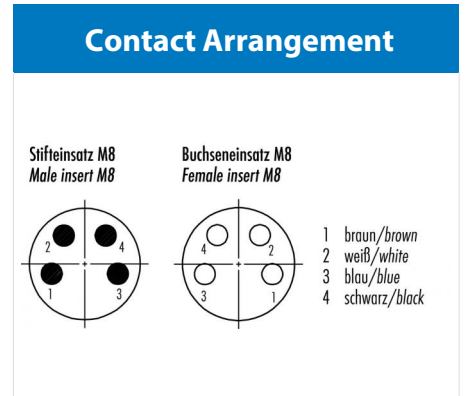
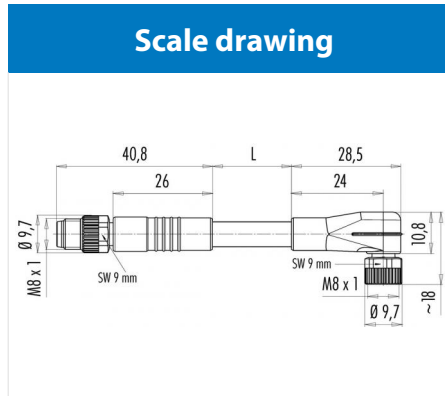

Technical data

Common values

Connector Design	Connecting cord
Connector locking system	screw
Termination	crimp, injection-moulded cable
Wire gauge (mm)	0.25 mm ²
Wire gauge (AWG)	24
Upper temperature	85 °C
Lower temperature	-25 °C

Electrical values

Rated voltage	30 V
Rated impulse voltage	800 V
Pollution degree	3
Overvoltage category	II
Material group	II
Rated current (40°C)	4 A
Volume resistivity	≤ 3 mΩ
EMV compliance	nicht geschirmt
Degree of protection	IP67
Mechanical operation	> 100 mating cycles

Material

Material of contact	Pin/ CuZn (brass), socket/ CuSn (bronze)
Contact plating	Au (Gold)
Material of contact body	PUR
Material of housing	PUR

Contacts 4: Connecting cord, 2m, cable plug connector M8 x 1 - female angled connector M8 x 1, cable 4 x 0.25 PUR